



# 315 GC

## Hydraulic Excavator

# Technical Specifications

Configurations and features may vary by region. Please consult your Cat® dealer for availability in your area.

## Table of Contents

<b>Specifications</b> .....	<b>2</b>
Engine .....	2
Swing Mechanism .....	2
Weights .....	2
Track .....	2
Drive .....	2
Hydraulic System .....	2
Service Refill Capacities .....	2
Standards .....	2
Sound Performance .....	2
Air Conditioning System .....	2
Operating Weights and Ground Pressures .....	3
Major Component Weights .....	4
Dimensions .....	5
Working Ranges and Forces .....	7
Blade Working Ranges .....	8
Reach Boom Lift Capacities – Counterweight: 3.83 mt (8,440 lb) .....	9
Bucket Specifications and Compatibility .....	24
Attachments Offering Guide .....	26
<b>Standard and Optional Equipment</b> .....	<b>28</b>
<b>Dealer Installed Kits and Attachments</b> .....	<b>30</b>

# 315 GC Hydraulic Excavator Specifications

## Engine

Engine Model	Cat® C3.6	
Net Power – ISO 9249:2007	73 kW	98 hp
Engine Power – ISO 14396:2002	74 kW	100 hp
Bore	98 mm	4 in
Stroke	120 mm	5 in
Displacement	3.6 L	220 in <sup>3</sup>

- Meets U.S. EPA Tier 4 Final and EU Stage V emission standards.
- No engine power derating required below 3000 m (9,840 ft) altitude.
- ISO 9249 is net power available at the flywheel when the engine is equipped with fan, air cleaner, aftertreatment, and alternator with engine speed at 2,400 rpm.

## Swing Mechanism

Swing Speed	11.5 rpm	
Maximum Swing Torque	35 kN·m	25,815 lbf-ft

## Weights

Operating Weight	15 400 kg	34,000 lb
------------------	-----------	-----------

- Long undercarriage, Reach Boom + R3.0 (9'10") stick, GD 0.68 m<sup>3</sup> (0.89 yd<sup>3</sup>) bucket, 700 mm (28") triple grouser shoes and 3.83 mt (8,440 lb) counterweight.

## Track

Standard Track Shoes Width	700 mm	28 in
Optional Track Shoes Width	600 mm	24 in
Optional Track Shoes Width	500 mm	20 in
Number of Shoes (each side)	46	
Number of Track Rollers (each side)	7	
Number of Carrier Rollers (each side)	1	

## Drive

Maximum Gradeability	35°/70%	
Maximum Travel Speed	5.4 km/h	3.4 mph
Maximum Drawbar Pull	117 kN	26,303 lbf

## Hydraulic System

Main System – Maximum Flow – Implement	247 L/min	65 gal/min
Maximum Pressure – Equipment – Normal	35 000 kPa	5,075 psi
Maximum Pressure – Travel	35 000 kPa	5,075 psi
Maximum Pressure – Swing	26 000 kPa	3,770 psi
Boom Cylinder – Bore	105 mm	4 in
Boom Cylinder – Stroke	1023 mm	40 in
Stick Cylinder – Bore	115 mm	5 in
Stick Cylinder – Stroke	1147 mm	45 in
Bucket Cylinder – Bore	95 mm	4 in
Bucket Cylinder – Stroke	939 mm	37 in

## Service Refill Capacities

Fuel Tank Capacity	187 L	49.4 gal
Cooling System	15 L	4.0 gal
Engine Oil	8 L	2.1 gal
Final Drive (each)	3 L	0.8 gal
Hydraulic System (including tank)	138 L	36.5 gal
Hydraulic Tank	72 L	19.0 gal

## Standards

Brakes	ISO 10265:2008
Cab/ROPS	ISO 12117-2:2008
Cab/FOGS	ISO 10262:1998

## Sound Performance

ISO 6395 (external)	101 dB(A)
ISO 6396 (inside cab)	68 dB(A)

- When properly installed and maintained, the cab offered by Caterpillar, when tested with doors and windows closed according to ANSI/SAE J1166 OCT98, meets OSHA and MSHA requirements for operator sound exposure limits in effect at time of manufacture.
- Hearing protection may be needed when operating with an open operator station and cab (when not properly maintained or doors/windows open) for extended periods or in a noisy environment.

## Air Conditioning System

The air conditioning system on this machine contains the fluorinated greenhouse gas refrigerant R134a (Global Warming Potential = 1430). The system contains 0.8 kg of refrigerant which has a CO<sub>2</sub> equivalent of 1.144 metric tonnes.

# 315 GC Hydraulic Excavator Specifications

## Operating Weights and Ground Pressures

Base Machine Configurations	500 mm (20") Triple Grouser Shoes		500 mm (20") Triple Grouser Shoes with Rubber Pad	500 mm (20") Rubber Shoe	600 mm (24") Triple Grouser Shoes		700 mm (28") Triple Grouser Shoes	
	Weight	Ground Pressure	Weight	Weight	Weight	Ground Pressure	Weight	Ground Pressure
	kg (lb)	kPa (psi)	kg (lb)	kg (lb)	kg (lb)	kPa (psi)	kg (lb)	kPa (psi)
<b>Base Frame with Track Rollers and Carrier Rollers</b>								
<b>Base Machine with 3.83 mt (8,440 lb) Counterweight and Long Undercarriage</b>								
Reach Boom + R2.5 (8'2") Stick + 0.68 m <sup>3</sup> (0.89 yd <sup>3</sup> ) GD Bucket	14 900 (32,800)	44.4 (6.4)	15 400 (33,900)	15 000 (33,100)	15 200 (33,500)	37.8 (5.5)	15 400 (34,000)	32.8 (4.8)
Reach Boom + R3.0 (9'10") Stick + 0.68 m <sup>3</sup> (0.89 yd <sup>3</sup> ) GD Bucket	15 000 (33,100)	44.7 (6.5)	15 400 (33,900)	15 100 (33,300)	15 200 (33,500)	37.8 (5.5)	15 400 (34,000)	32.8 (4.8)
Reach Boom + R2.5 (8'2") Stick + 0.68 m <sup>3</sup> (0.89 yd <sup>3</sup> ) GD Bucket + Blade	15 600 (34,400)	46.5 (6.7)	16 000 (35,300)	15 700 (34,600)	15 900 (35,100)	39.5 (5.7)	16 200 (35,700)	34.5 (5.0)
Reach Boom + R3.0 (9'10") Stick + 0.68 m <sup>3</sup> (0.89 yd <sup>3</sup> ) GD Bucket + Blade	15 700 (34,600)	46.8 (6.8)	16 100 (35,400)	15 800 (34,800)	16 000 (35,300)	39.8 (5.8)	16 200 (35,700)	34.5 (5.0)

All operating weights include a 90% fuel tank with 75 kg (165 lb) operator.

# 315 GC Hydraulic Excavator Specifications

## Major Component Weights

	kg	lb
Base Machine Weight: Base machine (with 3.83 mt [8,440 lb] counterweight, upper frame, long undercarriage – does not include boom, stick, bucket, boom cylinders, stick cylinders, bucket cylinders, tracks, blade, fuel tank, operator).		
With Long Undercarriage	10 770	23,730
With Long Undercarriage (blade compatible)	11 050	24,360
Track Shoes:		
500 mm (20") Triple Grouser Track Shoes	1540	3,390
500 mm (20") Triple Grouser Track Shoes with Rubber Pad	2050	4,520
500 mm (20") Rubber Shoe	1670	3,680
600 mm (24") Triple Grouser Track Shoes	1810	4,000
700 mm (28") Triple Grouser Track Shoes with Additional Steps	2020	4,440
Two Boom Cylinders	250	550
Weight of 90% Fuel Tank and 75 kg (165 lb) Operator	210	460
Blades (without lines, cylinders, frame modifications):		
2500 mm (8'2") Blade for use with 500 mm (20") Track Shoes	440	960
2600 mm (8'6") Blade for use with 600 mm (24") Track Shoes	490	1,080
2700 mm (8'10") Blade for use with 700 mm (28") Track Shoes	500	1,110
Counterweight:		
3.83 mt (8,440 lb) Counterweight	3830	8,440
Swing Frame	1420	3,140
Undercarriage:		
Base Frame with GD Track Rollers and One Carrier Roller for Long Undercarriage	2620	5,770
Base Frame with GD Track Rollers and One Carrier Roller for Long Undercarriage (blade compatible)	2900	6,390
Boom (including lines, pins, stick cylinder):		
Reach Boom 4.65 m (15'3")	1030	2,270
Sticks (including lines, pins, bucket cylinder, bucket linkage):		
Reach Stick R2.5 m (8'2")	590	1,300
Reach Stick R3.0 m (9'10")	650	1,440
Buckets (without linkage, with tips and side cutters):		
0.53 m <sup>3</sup> (0.69 yd <sup>3</sup> ) General Duty Bucket	420	940
0.68 m <sup>3</sup> (0.89 yd <sup>3</sup> ) General Duty Bucket	500	1,090
0.76 m <sup>3</sup> (0.99 yd <sup>3</sup> ) General Duty Bucket	520	1,150
Quick Coupler:		
Pin Grabber Quick Coupler	210	470

# 315 GC Hydraulic Excavator Specifications

## Dimensions

All dimensions are approximate and may vary depending on bucket selection.

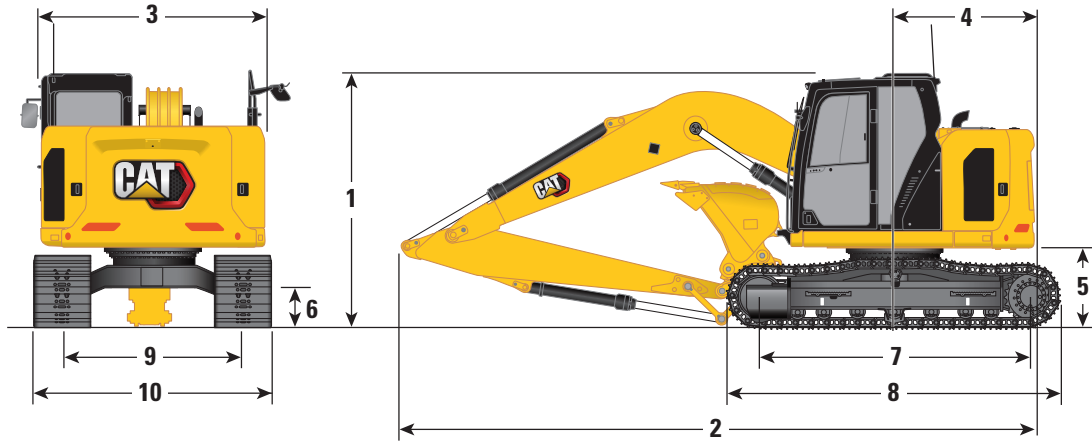

### Boom Options

**Reach Boom**  
4.65 m (15'3")

### Stick Options

**Reach Sticks**

**R2.5 (8'2")**

**R3.0 (9'10")**

#### 1 Machine Height:

	R2.5 (8'2")	R3.0 (9'10")
Top of Cab Height	2810 mm 9'3"	2810 mm 9'3"
Top of FOGS Height	2960 mm 9'9"	2960 mm 9'9"
Handrails Height	2860 mm 9'5"	2860 mm 9'5"
With Boom/Stick/Bucket Installed (with stick cylinder lines)	2890 mm 9'6"	3180 mm 10'5"
With Boom/Stick Installed (with stick cylinder lines)	2890 mm 9'6"	3180 mm 10'5"
With Boom Installed (with stick cylinder lines)	2410 mm 7'11"	2410 mm 7'11"

#### Machine Height (with 500 mm [20"] rubber shoe):

Top of Cab Height	2860 mm 9'5"	2860 mm 9'5"
Top of FOGS Height	3010 mm 9'11"	3010 mm 9'11"
Handrails Height	2910 mm 9'7"	2910 mm 9'7"
With Boom/Stick/Bucket Installed (with stick cylinder lines)	2940 mm 9'8"	3230 mm 10'7"
With Boom/Stick Installed (with stick cylinder lines)	2940 mm 9'8"	3230 mm 10'7"
With Boom Installed (with stick cylinder lines)	2460 mm 8'1"	2460 mm 8'1"

#### 2 Machine Length (without blade):

With Boom/Stick/Bucket Installed (with stick cylinder lines)	7440 mm 24'5"	7530 mm 24'8"
With Boom/Stick Installed (with stick cylinder lines)	7440 mm 24'5"	7530 mm 24'8"
With Boom Installed (with stick cylinder lines)	6640 mm 21'9"	6640 mm 21'9"

#### Machine Length (with blade, blade rear):

With Boom/Stick/Bucket Installed (with stick cylinder lines)	8000 mm 26'3"	8090 mm 26'7"
With Boom/Stick Installed (with stick cylinder lines)	8000 mm 26'3"	8090 mm 26'7"
With Boom Installed (with stick cylinder lines)	7200 mm 23'7"	7200 mm 23'7"

#### Bucket Type

GD

GD

Bucket Capacity	0.68 m <sup>3</sup> 0.89 yd <sup>3</sup>	0.68 m <sup>3</sup> 0.89 yd <sup>3</sup>
Bucket Tip Radius	1240 mm 4'1"	1240 mm 4'1"

# 315 GC Hydraulic Excavator Specifications

## Dimensions

All dimensions are approximate and may vary depending on bucket selection.

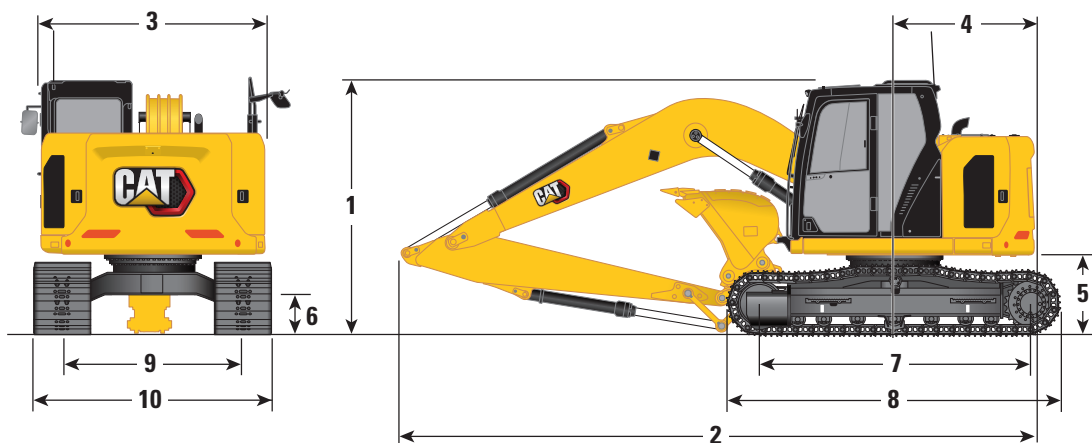

### Boom Options

Reach Boom  
4.65 m (15'3")

### Stick Options

Reach Sticks

R2.5 (8'2")

R3.0 (9'10")

	R2.5 (8'2")		R3.0 (9'10")	
<b>3</b> Upperframe Width	2480 mm	8'2"	2480 mm	8'2"
<b>4</b> Tail Swing Radius – 3.83 mt (8,440 lb) Counterweight	1570 mm	5'2"	1570 mm	5'2"
<b>5</b> Counterweight Clearance	880 mm	2'11"	880 mm	2'11"
<b>6</b> Ground Clearance	440 mm	1'5"	440 mm	1'5"
<b>7</b> Length to Center of Rollers	3040 mm	10'0"	3040 mm	10'0"
<b>8</b> Overall Track Length	3750 mm	12'4"	3750 mm	12'4"
<b>9</b> Track Gauge	1990 mm	6'6"	1990 mm	6'6"
<b>10</b> Track Width/Undercarriage Width:				
500 mm (20") Shoes	2490 mm	8'2"	2490 mm	8'2"
600 mm (24") Shoes	2590 mm	8'6"	2590 mm	8'6"
700 mm (28") Shoes (with steps)	2690 mm	8'10"	2690 mm	8'10"
Bucket Type	GD		GD	
Bucket Capacity	0.68 m <sup>3</sup>	0.89 yd <sup>3</sup>	0.68 m <sup>3</sup>	0.89 yd <sup>3</sup>
Bucket Tip Radius	1240 mm	4'1"	1240 mm	4'1"

# 315 GC Hydraulic Excavator Specifications

## Working Ranges and Forces

All dimensions are approximate and may vary depending on bucket selection.

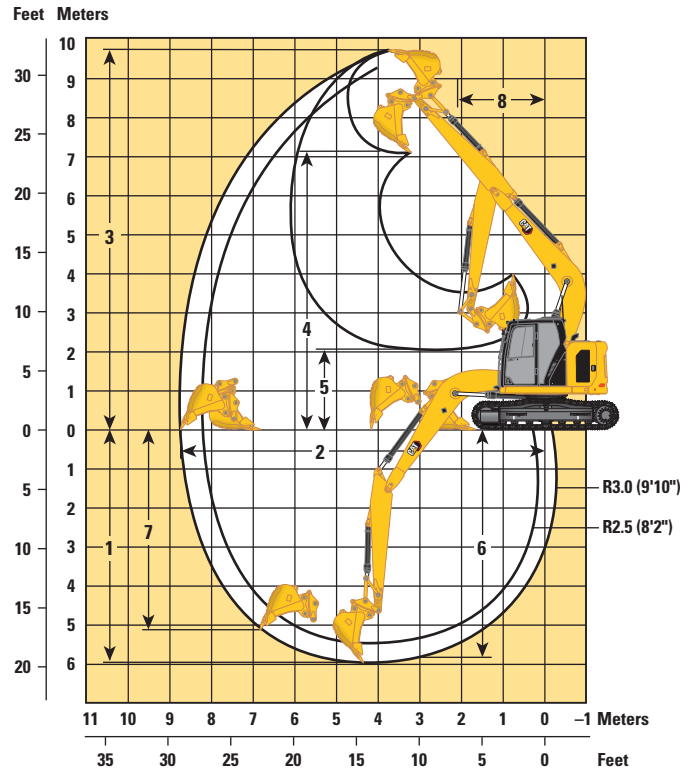

### Boom Options

**Reach Boom**  
4.65 m (15'3")

### Stick Options

**Reach Stick**

	R2.5 (8'2")		R3.0 (9'10")	
	GD	GD	GD	GD
<b>1</b> Maximum Digging Depth	5490 mm	18'0"	5990 mm	19'8"
<b>2</b> Maximum Reach at Ground Line	8230 mm	27'0"	8690 mm	28'6"
<b>3</b> Maximum Cutting Height	9330 mm	30'7"	9690 mm	31'9"
<b>4</b> Maximum Loading Height	6850 mm	22'6"	7220 mm	23'8"
<b>5</b> Minimum Loading Height	2520 mm	8'3"	2080 mm	6'10"
<b>6</b> Maximum Depth Cut for 2440 mm (8'0") Level Bottom	5280 mm	17'4"	5810 mm	19'1"
<b>7</b> Maximum Vertical Wall Digging Depth	4740 mm	15'7"	5180 mm	17'0"
<b>8</b> Minimum Working Equipment Radius	1980 mm	6'6"	2240 mm	7'4"
Bucket Digging Force (ISO)	98.45 kN	22,130 lbf	98.67 kN	22,180 lbf
Stick Digging Force (ISO)	66.68 kN	14,990 lbf	59.29 kN	13,330 lbf
Bucket Type	GD		GD	
Bucket Capacity	0.68 m <sup>3</sup>	0.89 yd <sup>3</sup>	0.68 m <sup>3</sup>	0.89 yd <sup>3</sup>
Bucket Tip Radius	1240 mm	4'1"	1240 mm	4'1"

# 315 GC Hydraulic Excavator Specifications

## Blade Working Ranges

All dimensions are approximate and may vary depending on bucket selection.

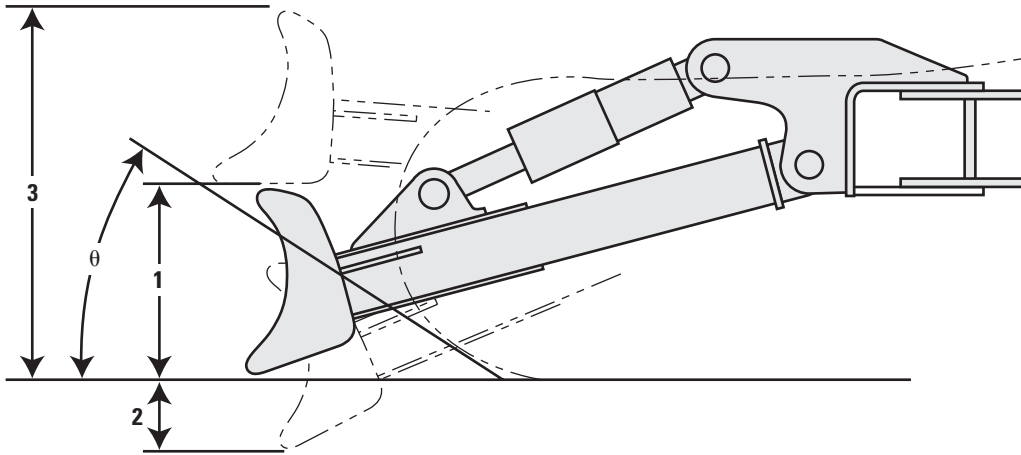

Blade Options	2500 mm (8'2")		2600 mm (8'6")		2700 mm (8'10")	
	<b>1</b> Blade Height	627 mm	2'1"	627 mm	2'1"	627 mm
<b>2</b> Maximum Lowering Depth from Ground	576 mm	1'11"	576 mm	1'11"	576 mm	1'11"
<b>3</b> Maximum Raising Height above Ground	990 mm	3'3"	990 mm	3'3"	990 mm	3'3"
<b>θ</b> Approach Angle	24°		24°		24°	



# 315 GC Hydraulic Excavator Specifications

## Reach Boom Lift Capacities – Counterweight: 3.83 mt (8,440 lb) – without Bucket

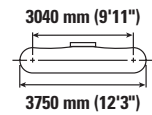
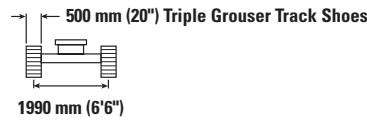
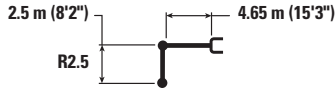

Reach Boom Lift Capacity	1500 mm (5'0")		3000 mm (10'0")		4500 mm (15'0")		6000 mm (20'0")		315 GC Hydraulic Excavator		mm ft/in	
	ISO 10567	ISO 10567	ISO 10567	ISO 10567	ISO 10567	ISO 10567	ISO 10567	ISO 10567	ISO 10567	ISO 10567		
7500 mm 25'0"	kg lb		*4350 *9,200	*4350 *9,200					*3250 *7,450	*3250 *7,450	3710 11'5"	
6000 mm 20'0"	kg lb				*4050 *8,750	*4050 *8,750			*2600 *5,800	*2600 *5,800	5490 17'8"	
4500 mm 15'0"	kg lb		*4150 *9,050	*4150 *9,050	*4500 *9,750	4050 8,700	*3700 *7,600	2550 5,500	*2450 *5,350	2250 5,050	6460 21'0"	
3000 mm 10'0"	kg lb		*7400 *15,850	7400 15,450	*5150 *11,150	3850 8,250	3900 8,350	2500 5,350	*2450 *5,350	1950 4,300	6970 22'9"	
1500 mm 5'0"	kg lb		*6800 *16,700	6400 13,800	*5850 *12,600	3600 7,750	3800 8,100	2400 5,150	*2550 *5,600	1850 4,050	7130 23'4"	
0 mm 0'0"	kg lb		*6250 *14,500	6100 13,150	5650 12,150	3400 7,350	3700 7,900	2300 4,950	*2850 *6,250	1900 4,150	6960 22'9"	
-1500 mm -5'0"	kg lb	*4750 *10,700	*4750 *10,700	*7900 *17,150	6100 13,050	*5550 *11,950	3350 7,200	3650 7,850	2250 4,900	3300 7,300	2100 4,550	6440 21'0"
-3000 mm -10'0"	kg lb	*7300 *15,650	*7300 *15,650	*5750 *12,350	*5750 *12,350	*4150 *8,750	3400 7,300		*2950 *6,400	2650 5,850	5460 17'9"	

## Reach Boom Lift Capacities – Counterweight: 3.83 mt (8,440 lb) – without Bucket

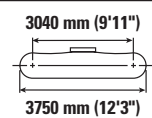
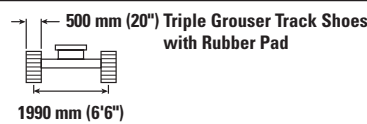
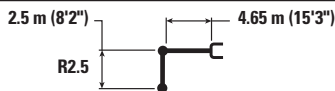

Reach Boom Lift Capacity	1500 mm (5'0")		3000 mm (10'0")		4500 mm (15'0")		6000 mm (20'0")		315 GC Hydraulic Excavator		mm ft/in	
	ISO 10567	ISO 10567	ISO 10567	ISO 10567	ISO 10567	ISO 10567	ISO 10567	ISO 10567	ISO 10567	ISO 10567		
7500 mm 25'0"	kg lb		*4350 *9,200	*4350 *9,200					*3250 *7,450	*3250 *7,450	3710 11'5"	
6000 mm 20'0"	kg lb				*4050 *8,750	*4050 *8,750			*2600 *5,800	*2600 *5,800	5490 17'8"	
4500 mm 15'0"	kg lb		*4150 *9,050	*4150 *9,050	*4500 *9,750	4200 9,000	*3700 *7,600	2650 5,700	*2450 *5,350	2350 5,200	6460 21'0"	
3000 mm 10'0"	kg lb		*7400 *15,850	7400 *15,850	*5150 *11,150	3950 8,550	4050 8,650	2600 5,550	*2450 *5,350	2050 4,500	6970 22'9"	
1500 mm 5'0"	kg lb		*6800 *16,700	6650 14,250	*5850 *12,600	3700 8,000	3900 8,400	2500 5,300	*2550 *5,600	1950 4,200	7130 23'4"	
0 mm 0'0"	kg lb		*6250 *14,500	*6250 13,600	5850 12,550	3550 7,600	3800 8,200	2400 5,150	*2850 *6,250	1950 4,300	6960 22'9"	
-1500 mm -5'0"	kg lb	*4750 *10,700	*4750 *10,700	*7900 *17,150	6300 13,500	*5550 *11,950	3450 7,450	3800 8,150	2350 5,050	*3400 *7,450	2150 4,750	6440 21'0"
-3000 mm -10'0"	kg lb	*7300 *15,650	*7300 *15,650	*5750 *12,350	*5750 *12,350	*4150 *8,750	3500 7,550		*2950 *6,400	2750 6,050	5460 17'9"	



ISO 10567



\* Indicates that the load is limited by hydraulic lifting capacity rather than tipping load. The above loads are in compliance with hydraulic excavator lift capacity standard ISO 10567:2007. They do not exceed 87% of hydraulic lifting capacity or 75% of tipping load. Weight of all lifting accessories must be deducted from the above lifting capacities. Lifting capacities are based on the machine standing on a firm, uniform supporting surface. The use of a work tool attachment point to handle/lift objects, could affect the machine lift performance.

Lift capacity stays with ±5% for all available track shoes.

Always refer to the appropriate Operation and Maintenance Manual for specific product information.

# 315 GC Hydraulic Excavator Specifications

## Reach Boom Lift Capacities – Counterweight: 3.83 mt (8,440 lb) – without Bucket

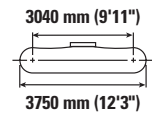
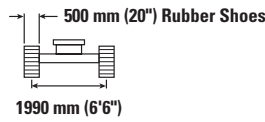
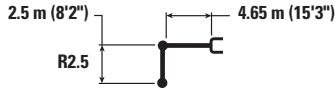

Reach Boom mm ft/in	Unit	1500 mm (5'0")		3000 mm (10'0")		4500 mm (15'0")		6000 mm (20'0")		315 GC Hydraulic Excavator		mm ft/in
		ISO 10567	ISO 10567	ISO 10567	ISO 10567	ISO 10567	ISO 10567	ISO 10567	ISO 10567	ISO 10567	ISO 10567	
7500 mm 25'0"	kg lb			*4350 *9,200	*4350 *9,200					*3250 *7,450	*3250 *7,450	3710 11'5"
6000 mm 20'0"	kg lb					*4050 *8,750	*4050 *8,750			*2600 *5,800	*2600 *5,800	5490 17'8"
4500 mm 15'0"	kg lb			*4150 *9,050	*4150 *9,050	*4500 *9,750	4100 8,800	*3700 *7,600	2600 5,550	*2450 *5,350	2300 5,050	6460 21'0"
3000 mm 10'0"	kg lb			*7400 *15,850	7250 15,550	*5150 *11,150	3900 8,350	3950 8,450	2500 5,400	*2450 *5,350	2000 4,350	6970 22'9"
1500 mm 5'0"	kg lb			*6800 *16,700	6500 13,950	*5850 *12,600	3600 7,800	3800 8,200	2400 5,200	*2550 *5,600	1900 4,100	7130 23'4"
0 mm 0'0"	kg lb			*6250 *14,500	6200 13,250	5700 12,250	3450 7,400	3700 8,000	2350 5,000	*2850 *6,250	1900 4,150	6960 22'9"
-1500 mm -5'0"	kg lb	*4750 *10,700	*4750 *10,700	*7900 *17,150	6150 13,150	*5550 *11,950	3350 7,250	3700 7,900	2300 4,950	3350 7,400	2100 4,600	6440 21'0"
-3000 mm -10'0"	kg lb	*7300 *15,650	*7300 *15,650	*5750 *12,350	*5750 *12,350	*4150 *8,750	3400 7,350			*2950 *6,400	2650 5,900	5460 17'9"

## Reach Boom Lift Capacities – Counterweight: 3.83 mt (8,440 lb) – without Bucket

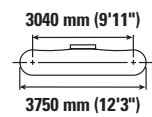
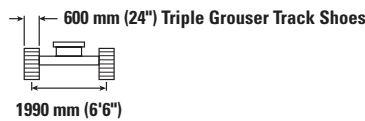
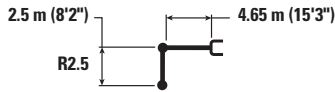

Reach Boom mm ft/in	Unit	1500 mm (5'0")		3000 mm (10'0")		4500 mm (15'0")		6000 mm (20'0")		315 GC Hydraulic Excavator		mm ft/in
		ISO 10567	ISO 10567	ISO 10567	ISO 10567	ISO 10567	ISO 10567	ISO 10567	ISO 10567	ISO 10567	ISO 10567	
7500 mm 25'0"	kg lb			*4350 *9,200	*4350 *9,200					*3250 *7,450	*3250 *7,450	3710 11'5"
6000 mm 20'0"	kg lb					*4050 *8,750	*4050 *8,750			*2600 *5,800	*2600 *5,800	5490 17'8"
4500 mm 15'0"	kg lb			*4150 *9,050	*4150 *9,050	*4500 *9,750	4100 8,850	*3700 *7,600	2600 5,600	*2450 *5,350	2300 5,100	6460 21'0"
3000 mm 10'0"	kg lb			*7400 *15,850	7300 15,700	*5150 *11,150	3900 8,400	3950 8,500	2550 5,450	*2450 *5,350	2000 4,400	6970 22'9"
1500 mm 5'0"	kg lb			*6800 *16,700	6550 14,050	*5850 *12,600	3650 7,850	3850 8,250	2450 5,250	*2550 *5,600	1900 4,150	7130 23'4"
0 mm 0'0"	kg lb			*6250 *14,500	6250 13,400	5750 12,350	3500 7,450	3750 8,050	2350 5,050	*2850 *6,250	1900 4,200	6960 22'9"
-1500 mm -5'0"	kg lb	*4750 *10,700	*4750 *10,700	*7900 *17,150	6200 13,300	*5550 *11,950	3400 7,300	3700 8,000	2300 5,000	*3400 *7,450	2100 4,650	6440 21'0"
-3000 mm -10'0"	kg lb	*7300 *15,650	*7300 *15,650	*5750 *12,350	*5750 *12,350	*4150 *8,750	3450 7,400			*2950 *6,400	2700 5,950	5460 17'9"



ISO 10567



\* Indicates that the load is limited by hydraulic lifting capacity rather than tipping load. The above loads are in compliance with hydraulic excavator lift capacity standard ISO 10567:2007.

They do not exceed 87% of hydraulic lifting capacity or 75% of tipping load. Weight of all lifting accessories must be deducted from the above lifting capacities. Lifting capacities are based on the machine standing on a firm, uniform supporting surface. The use of a work tool attachment point to handle/lift objects, could affect the machine lift performance.

Lift capacity stays with ±5% for all available track shoes.

Always refer to the appropriate Operation and Maintenance Manual for specific product information.

# 315 GC Hydraulic Excavator Specifications

## Reach Boom Lift Capacities – Counterweight: 3.83 mt (8,440 lb) – without Bucket

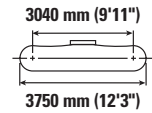
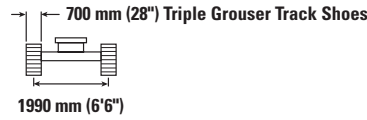
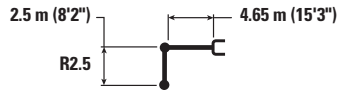

Reach Boom Lift Capacity	1500 mm (5'0")		3000 mm (10'0")		4500 mm (15'0")		6000 mm (20'0")		3040 mm (9'11") 3750 mm (12'3")		mm ft/in
	kg lb	kg lb	kg lb	kg lb	kg lb	kg lb	kg lb	kg lb	kg lb	kg lb	
7500 mm 25'0"			*4350 *9,200	*4350 *9,200					*3250 *7,450	*3250 *7,450	3710 11'5"
6000 mm 20'0"					*4050 *8,750	*4050 *8,750			*2600 *5,800	*2600 *5,800	5490 17'8"
4500 mm 15'0"			*4150 *9,050	*4150 *9,050	*4500 *9,750	4150 8,950	*3700 *7,600	2650 5,650	*2450 *5,350	2350 5,200	6460 21'0"
3000 mm 10'0"			*7400 *15,850	7350 *15,850	*5150 *11,150	3950 8,500	4000 8,650	2600 5,500	*2450 *5,350	2050 4,500	6970 22'9"
1500 mm 5'0"			*6800 *16,700	6600 14,250	*5850 *12,600	3700 7,950	3900 8,400	2450 5,300	*2550 *5,600	1900 4,200	7130 23'4"
0 mm 0'0"			*6250 *14,500	*6250 13,550	5850 12,550	3500 7,550	3800 8,200	2400 5,100	*2850 *6,250	1950 4,250	6960 22'9"
-1500 mm -5'0"	*4750 *10,700	*4750 *10,700	*7900 *17,150	6300 13,500	*5550 *11,950	3450 7,400	3750 8,100	2350 5,050	*3400 *7,450	2150 4,750	6440 21'0"
-3000 mm -10'0"	*7300 *15,650	*7300 *15,650	*5750 *12,350	*5750 *12,350	*4150 *8,750	3500 7,500			*2950 *6,400	2700 6,050	5460 17'9"

## Reach Boom Lift Capacities – Counterweight: 3.83 mt (8,440 lb) – without Bucket

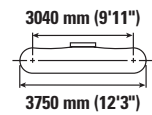
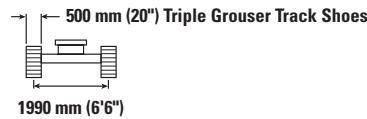

Reach Boom Lift Capacity	1500 mm (5'0")		3000 mm (10'0")		4500 mm (15'0")		6000 mm (20'0")		7500 mm (25'0")		3040 mm (9'11") 3750 mm (12'3")		mm ft/in
	kg lb	kg lb	kg lb	kg lb	kg lb	kg lb	kg lb	kg lb	kg lb	kg lb	kg lb		
7500 mm 25'0"					*2700 *2700	*2700 *2700					*2600 *5,850	*2600 *5,850	4540 14'3"
6000 mm 20'0"					*3450 *7,550	*3450 *7,550	*2400 *2400	*2400 *2400			*2200 *4,850	*2200 *4,850	6070 19'8"
4500 mm 15'0"					*3650 *7,950	*3650 *7,950	*3450 *7,400	2600 5,600			*2050 *4,500	2000 4,450	6960 22'8"
3000 mm 10'0"			*5850 *12,100	*5850 *12,100	*4800 *10,350	3900 8,400	3950 8,400	2500 5,400			*2050 *4,500	1800 3,900	7440 24'4"
1500 mm 5'0"			*8750 *18,800	6600 14,150	*5600 *12,050	3650 7,800	3800 8,150	2400 5,150	*2500 1700		*2150 *4,750	1700 3,700	7590 24'10"
0 mm 0'0"			*7000 *16,150	6150 13,150	5650 12,150	3400 7,350	3650 7,900	2300 4,900			*2400 *5,250	1700 3,700	7430 24'4"
-1500 mm -5'0"	*4300 *9,650	*4300 *9,650	*8500 *18,350	6000 12,900	5550 11,900	3300 7,100	3600 7,750	2250 4,800			*2850 *6,250	1850 4,050	6940 22'8"
-3000 mm -10'0"	*7450 *16,700	*7450 *16,700	*6650 *14,350	6050 13,000	*4700 *10,000	3300 7,100	*3000 6,600	2250 4,950			*2950 *6,400	2250 4,950	6050 19'8"
-4500 mm -15'0"			*3450 *7,050	*3450 *7,050							*2050 *4,250	*2050 *4,250	4490 14'4"



ISO 10567



\* Indicates that the load is limited by hydraulic lifting capacity rather than tipping load. The above loads are in compliance with hydraulic excavator lift capacity standard ISO 10567:2007. They do not exceed 87% of hydraulic lifting capacity or 75% of tipping load. Weight of all lifting accessories must be deducted from the above lifting capacities. Lifting capacities are based on the machine standing on a firm, uniform supporting surface. The use of a work tool attachment point to handle/lift objects, could affect the machine lift performance.

Lift capacity stays with ±5% for all available track shoes.

Always refer to the appropriate Operation and Maintenance Manual for specific product information.

# 315 GC Hydraulic Excavator Specifications

## Reach Boom Lift Capacities – Counterweight: 3.83 mt (8,440 lb) – without Bucket

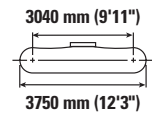
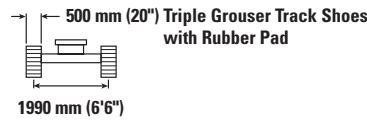
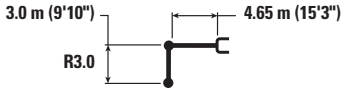

		1500 mm (5'0")		3000 mm (10'0")		4500 mm (15'0")		6000 mm (20'0")		7500 mm (25'0")		mm ft/in		
7500 mm 25'0"	kg lb					*2700	*2700					*2600 *5,850	*2600 *5,850	4540 14'3"
6000 mm 20'0"	kg lb					*3450 *7,550	*3450 *7,550	*2400	*2400			*2200 *4,850	*2200 *4,850	6070 19'8"
4500 mm 15'0"	kg lb					*3650 *7,950	*3650 *7,950	*3450 *7,400	2700 5,750			*2050 *4,500	*2050 *4,500	6960 22'8"
3000 mm 10'0"	kg lb			*5850 *12,100	*5850 *12,100	*4800 *10,350	4050 8,650	*3950 *8,550	2600 5,600			*2050 *4,500	1850 4,050	7440 24'4"
1500 mm 5'0"	kg lb			*8750 *18,800	6800 14,650	*5600 *12,050	3750 8,050	3900 8,400	2500 5,300	*2500	1750	*2150 *4,750	1750 3,800	7590 24'10"
0 mm 0'0"	kg lb			*7000 *16,150	6350 13,600	5850 12,550	3550 7,600	3800 8,150	2350 5,100			*2400 *5,250	1750 3,850	7430 24'4"
-1500 mm -5'0"	kg lb	*4300 *9,650	*4300 *9,650	*8500 *18,350	6250 13,350	5750 12,300	3400 7,350	3750 8,050	2300 4,950			*2850 *6,250	1900 4,200	6940 22'8"
-3000 mm -10'0"	kg lb	*7450 *16,700	*7450 *16,700	*6650 *14,350	6300 13,450	*4700 *10,000	3450 7,350	*3000	2350			*2950 *6,400	2300 5,150	6050 19'8"
-4500 mm -15'0"	kg lb			*3450 *7,050	*3450 *7,050							*2050 *4,250	*2050 *4,250	4490 14'4"

## Reach Boom Lift Capacities – Counterweight: 3.83 mt (8,440 lb) – without Bucket

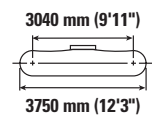
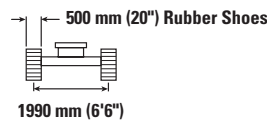
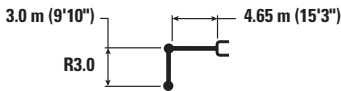

		1500 mm (5'0")		3000 mm (10'0")		4500 mm (15'0")		6000 mm (20'0")		7500 mm (25'0")		mm ft/in		
7500 mm 25'0"	kg lb					*2700	*2700					*2600 *5,850	*2600 *5,850	4540 14'3"
6000 mm 20'0"	kg lb					*3450 *7,550	*3450 *7,550	*2400	*2400			*2200 *4,850	*2200 *4,850	6070 19'8"
4500 mm 15'0"	kg lb					*3650 *7,950	*3650 *7,950	*3450 *7,400	2650 5,600			*2050 *4,500	2050 4,500	6960 22'8"
3000 mm 10'0"	kg lb			*5850 *12,100	*5850 *12,100	*4800 *10,350	3950 8,450	*3950 *8,500	2550 5,450			*2050 *4,500	1800 3,950	7440 24'4"
1500 mm 5'0"	kg lb			*8750 *18,800	6650 14,300	*5600 *12,050	3650 7,850	3850 8,200	2400 5,200	*2500	1750	*2150 *4,750	1700 3,700	7590 24'10"
0 mm 0'0"	kg lb			*7000 *16,150	6200 13,300	5700 12,250	3450 7,400	3700 7,950	2300 4,950			*2400 *5,250	1700 3,750	7430 24'4"
-1500 mm -5'0"	kg lb	*4300 *9,650	*4300 *9,650	*8500 *18,350	6050 13,000	5600 12,000	3350 7,150	3650 7,800	2250 4,850			*2850 *6,250	1850 4,100	6940 22'8"
-3000 mm -10'0"	kg lb	*7450 *16,700	*7450 *16,700	*6650 *14,350	6100 13,150	*4700 *10,000	3350 7,150	*3000	2300			*2950 *6,400	2250 5,000	6050 19'8"
-4500 mm -15'0"	kg lb			*3450 *7,050	*3450 *7,050							*2050 *4,250	*2050 *4,250	4490 14'4"



ISO 10567



\* Indicates that the load is limited by hydraulic lifting capacity rather than tipping load. The above loads are in compliance with hydraulic excavator lift capacity standard ISO 10567:2007. They do not exceed 87% of hydraulic lifting capacity or 75% of tipping load. Weight of all lifting accessories must be deducted from the above lifting capacities. Lifting capacities are based on the machine standing on a firm, uniform supporting surface. The use of a work tool attachment point to handle/lift objects, could affect the machine lift performance.

Lift capacity stays with ±5% for all available track shoes.

Always refer to the appropriate Operation and Maintenance Manual for specific product information.

# 315 GC Hydraulic Excavator Specifications

## Reach Boom Lift Capacities – Counterweight: 3.83 mt (8,440 lb) – without Bucket

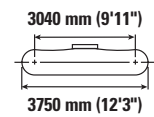
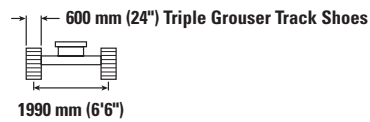
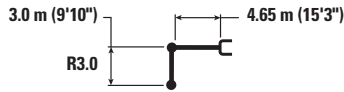

		1500 mm (5'0")		3000 mm (10'0")		4500 mm (15'0")		6000 mm (20'0")		7500 mm (25'0")		mm ft/in		
7500 mm 25'0"	kg lb					*2700	*2700					*2600 *5,850	*2600 *5,850	4540 14'3"
6000 mm 20'0"	kg lb					*3450 *7,550	*3450 *7,550	*2400	*2400			*2200 *4,850	*2200 *4,850	6070 19'8"
4500 mm 15'0"	kg lb					*3650 *7,950	*3650 *7,950	*3450 *7,400	2650 5,650			*2050 *4,500	2050 4,500	6960 22'8"
3000 mm 10'0"	kg lb			*5850 *12,100	*5850 *12,100	*4800 *10,350	3950 8,550	*3950 *8,550	2550 5,500			*2050 *4,500	1800 4,000	7440 24'4"
1500 mm 5'0"	kg lb			*8750 *18,800	6700 14,400	*5600 *12,050	3700 7,950	3850 8,300	2450 5,250	*2500	1750	*2150 *4,750	1700 3,750	7590 24'10"
0 mm 0'0"	kg lb			*7000 *16,150	6250 13,400	5750 12,350	3450 7,450	3750 8,050	2350 5,000			*2400 *5,250	1750 3,800	7430 24'4"
-1500 mm -5'0"	kg lb	*4300 *9,650	*4300 *9,650	*8500 *18,350	6150 13,150	5650 12,100	3350 7,250	3700 7,900	2300 4,900			*2850 *6,250	1900 4,150	6940 22'8"
-3000 mm -10'0"	kg lb	*7450 *16,700	*7450 *16,700	*6650 *14,350	6200 13,250	*4700 *10,000	3350 7,250	3000	2300			*2950 *6,400	2300 5,050	6050 19'8"
-4500 mm -15'0"	kg lb			*3450 *7,050	*3450 *7,050							*2050 *4,250	2050 4,250	4490 14'4"

## Reach Boom Lift Capacities – Counterweight: 3.83 mt (8,440 lb) – without Bucket

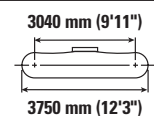
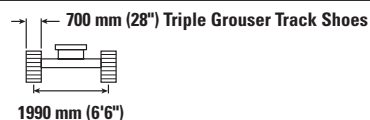

		1500 mm (5'0")		3000 mm (10'0")		4500 mm (15'0")		6000 mm (20'0")		7500 mm (25'0")		mm ft/in		
7500 mm 25'0"	kg lb					*2700	*2700					*2600 *5,850	*2600 *5,850	4540 14'3"
6000 mm 20'0"	kg lb					*3450 *7,550	*3450 *7,550	*2400	*2400			*2200 *4,850	*2200 *4,850	6070 19'8"
4500 mm 15'0"	kg lb					*3650 *7,950	*3650 *7,950	*3450 *7,400	2700 5,750			*2050 *4,500	*2050 *4,500	6960 22'8"
3000 mm 10'0"	kg lb			*5850 *12,100	*5850 *12,100	*4800 *10,350	4000 8,650	*3950 *8,550	2600 5,550			*2050 *4,500	1850 4,050	7440 24'4"
1500 mm 5'0"	kg lb			*8750 *18,800	6800 14,600	*5600 *12,050	3750 8,050	3900 8,400	2450 5,300	*2500	1750	*2150 *4,750	1750 3,800	7590 24'10"
0 mm 0'0"	kg lb			*7000 *16,150	6350 13,600	5850 12,550	3500 7,550	3800 8,150	2350 5,100			*2400 *5,250	1750 3,850	7430 24'4"
-1500 mm -5'0"	kg lb	*4300 *9,650	*4300 *9,650	*8500 *18,350	6200 13,300	5700 12,250	3400 7,350	3750 8,000	2300 4,950			*2850 *6,250	1900 4,200	6940 22'8"
-3000 mm -10'0"	kg lb	*7450 *16,700	*7450 *16,700	*6650 *14,350	6250 13,450	*4700 *10,000	3400 7,350	*3000	2350			*2950 *6,400	2300 5,100	6050 19'8"
-4500 mm -15'0"	kg lb			*3450 *7,050	*3450 *7,050							*2050 *4,250	*2050 *4,250	4490 14'4"



ISO 10567



\* Indicates that the load is limited by hydraulic lifting capacity rather than tipping load. The above loads are in compliance with hydraulic excavator lift capacity standard ISO 10567:2007. They do not exceed 87% of hydraulic lifting capacity or 75% of tipping load. Weight of all lifting accessories must be deducted from the above lifting capacities. Lifting capacities are based on the machine standing on a firm, uniform supporting surface. The use of a work tool attachment point to handle/lift objects, could affect the machine lift performance.

Lift capacity stays with ±5% for all available track shoes.

Always refer to the appropriate Operation and Maintenance Manual for specific product information.

# 315 GC Hydraulic Excavator Specifications

## Reach Boom Lift Capacities – Counterweight: 3.83 mt (8,440 lb) – without Bucket – Blade Up

2500 mm (8'2") Blade

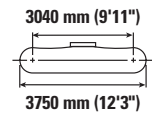
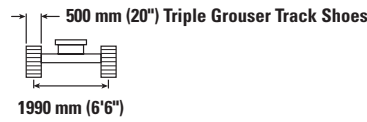
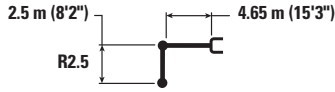

Blade Height	Unit	1500 mm (5'0")		3000 mm (10'0")		4500 mm (15'0")		6000 mm (20'0")		2500 mm (8'2") Blade		mm ft/in
		ISO 10567	ISO 10567	ISO 10567	ISO 10567	ISO 10567	ISO 10567	ISO 10567	ISO 10567	ISO 10567	ISO 10567	
7500 mm 25'0"	kg lb			*4350 *9,200	*4350 *9,200					*3250 *7,450	*3250 *7,450	3710 11'5"
6000 mm 20'0"	kg lb					*4050 *8,750	*4050 *8,750			*2600 *5,800	*2600 *5,800	5490 17'8"
4500 mm 15'0"	kg lb			*4150 *9,050	*4150 *9,050	*4500 *9,750	4250 9,100	*3700 *7,600	2700 5,750	*2450 *5,350	2400 5,250	6460 21'0"
3000 mm 10'0"	kg lb			*7400 *15,850	*7400 *15,850	*5150 *11,150	4000 8,650	3900 8,350	2600 5,600	*2450 *5,350	2050 4,550	6970 22'9"
1500 mm 5'0"	kg lb			*6800 *16,700	6700 14,450	*5850 12,550	3750 8,100	3750 8,100	2500 5,400	*2550 *5,600	1950 4,300	7130 23'4"
0 mm 0'0"	kg lb			*6250 *14,500	*6250 13,800	5650 12,100	3600 7,700	3700 7,900	2400 5,200	*2850 *6,250	2000 4,350	6960 22'9"
-1500 mm -5'0"	kg lb	*4750 *10,700	*4750 *10,700	*7900 *17,150	6400 13,700	*5550 11,950	3500 7,550	3650 7,800	2400 5,150	3300 7,300	2200 4,800	6440 21'0"
-3000 mm -10'0"	kg lb	*7300 *15,650	*7300 *15,650	*5750 *12,350	*5750 *12,350	*4150 *8,750	3550 7,650			*2950 *6,400	2750 6,150	5460 17'9"

## Reach Boom Lift Capacities – Counterweight: 3.83 mt (8,440 lb) – without Bucket – Blade Down

2500 mm (8'2") Blade

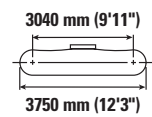
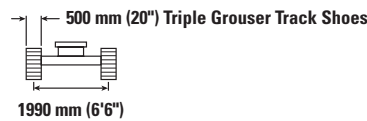
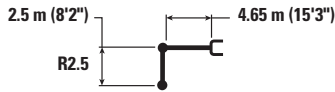

Blade Height	Unit	1500 mm (5'0")		3000 mm (10'0")		4500 mm (15'0")		6000 mm (20'0")		2500 mm (8'2") Blade		mm ft/in
		ISO 10567	ISO 10567	ISO 10567	ISO 10567	ISO 10567	ISO 10567	ISO 10567	ISO 10567	ISO 10567	ISO 10567	
7500 mm 25'0"	kg lb			*4350 *9,200	*4350 *9,200					*3250 *7,450	*3250 *7,450	3710 11'5"
6000 mm 20'0"	kg lb					*4050 *8,750	*4050 *8,750			*2600 *5,800	*2600 *5,800	5490 17'8"
4500 mm 15'0"	kg lb			*4150 *9,050	*4150 *9,050	*4500 *9,750	*4500 *9,750	*3700 *7,600	2900 6,250	*2450 *5,350	*2450 *5,350	6460 21'0"
3000 mm 10'0"	kg lb			*7400 *15,850	*7400 *15,850	*5150 *11,150	4350 9,400	*4150 *9,050	2850 6,100	*2450 *5,350	2250 4,950	6970 22'9"
1500 mm 5'0"	kg lb			*6800 *16,700	*6800 16,000	*5850 *12,600	4100 8,800	*4400 *9,500	2750 5,850	*2550 *5,600	2100 4,650	7130 23'4"
0 mm 0'0"	kg lb			*6250 *14,500	*6250 *14,500	*6050 *13,050	3900 8,400	*4400 *9,500	2650 5,650	*2850 *6,250	2150 4,750	6960 22'9"
-1500 mm -5'0"	kg lb	*4750 *10,700	*4750 *10,700	*7900 *17,150	7100 15,250	*5550 *11,950	3850 8,250	*3900 *8,350	2600 5,600	*3400 *7,450	2400 5,250	6440 21'0"
-3000 mm -10'0"	kg lb	*7300 *15,650	*7300 *15,650	*5750 *12,350	*5750 *12,350	*4150 *8,750	3900 8,350			*2950 *6,400	*2950 *6,400	5460 17'9"



ISO 10567



\* Indicates that the load is limited by hydraulic lifting capacity rather than tipping load. The above loads are in compliance with hydraulic excavator lift capacity standard ISO 10567:2007.

They do not exceed 87% of hydraulic lifting capacity or 75% of tipping load. Weight of all lifting accessories must be deducted from the above lifting capacities. Lifting capacities are based on the machine standing on a firm, uniform supporting surface. The use of a work tool attachment point to handle/lift objects, could affect the machine lift performance.

Lift capacity stays with ±5% for all available track shoes.









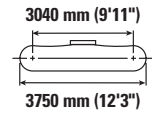
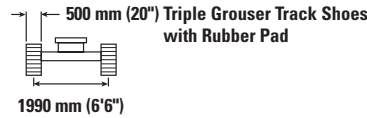
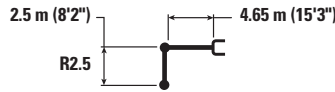

Always refer to the appropriate Operation and Maintenance Manual for specific product information.

# 315 GC Hydraulic Excavator Specifications

## Reach Boom Lift Capacities – Counterweight: 3.83 mt (8,440 lb) – without Bucket – Blade Up

2500 mm (8'2") Blade









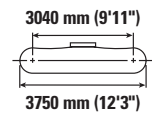
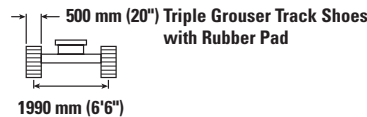



		1500 mm (5'0")		3000 mm (10'0")		4500 mm (15'0")		6000 mm (20'0")				mm ft/in
												
7500 mm 25'0"	kg lb			*4350 *9,200	*4350 *9,200					*3250 *7,450	*3250 *7,450	3710 11'5"
6000 mm 20'0"	kg lb					*4050 *8,750	*4050 *8,750			*2600 *5,800	*2600 *5,800	5490 17'8"
4500 mm 15'0"	kg lb			*4150 *9,050	*4150 *9,050	*4500 *9,750	4350 9,350	*3700 *7,600	2750 5,950	*2450 *5,350	*2450 *5,350	6460 21'0"
3000 mm 10'0"	kg lb			*7400 *15,850	*7400 *15,850	*5150 *11,150	4150 8,900	4000 8,600	2700 5,800	*2450 *5,350	2150 4,700	6970 22'9"
1500 mm 5'0"	kg lb			*6800 *16,700	*6800 14,900	*5850 *12,600	3900 8,350	3900 8,400	2600 5,550	*2550 *5,600	2000 4,450	7130 23'4"
0 mm 0'0"	kg lb			*6250 *14,500	*6250 14,250	5850 12,500	3700 7,950	3800 8,150	2500 5,400	*2850 *6,250	2050 4,500	6960 22'9"
-1500 mm -5'0"	kg lb	*4750 *10,700	*4750 *10,700	*7900 *17,150	6600 14,150	*5550 *11,950	3650 7,800	3750 8,100	2450 5,300	*3400 *7,450	2250 5,000	6440 21'0"
-3000 mm -10'0"	kg lb	*7300 *15,650	*7300 *15,650	*5750 *12,350	*5750 *12,350	*4150 *8,750	3650 7,900			*2950 *6,400	2850 6,350	5460 17'9"

## Reach Boom Lift Capacities – Counterweight: 3.83 mt (8,440 lb) – without Bucket – Blade Down

2500 mm (8'2") Blade



		1500 mm (5'0")		3000 mm (10'0")		4500 mm (15'0")		6000 mm (20'0")				mm ft/in
												
7500 mm 25'0"	kg lb			*4350 *9,200	*4350 *9,200					*3250 *7,450	*3250 *7,450	3710 11'5"
6000 mm 20'0"	kg lb					*4050 *8,750	*4050 *8,750			*2600 *5,800	*2600 *5,800	5490 17'8"
4500 mm 15'0"	kg lb			*4150 *9,050	*4150 *9,050	*4500 *9,750	*4500 *9,750	*3700 *7,600	3000 6,400	*2450 *5,350	*2450 *5,350	6460 21'0"
3000 mm 10'0"	kg lb			*7400 *15,850	*7400 *15,850	*5150 *11,150	4500 9,650	*4150 *9,050	2950 6,300	*2450 *5,350	2300 5,100	6970 22'9"
1500 mm 5'0"	kg lb			*6800 *16,700	*6800 16,500	*5850 *12,600	4250 9,100	*4400 *9,500	2800 6,050	*2550 *5,600	2200 4,800	7130 23'4"
0 mm 0'0"	kg lb			*6250 *14,500	*6250 *14,500	*6050 *13,050	4050 8,700	*4400 *9,500	2750 5,850	*2850 *6,250	2250 4,900	6960 22'9"
-1500 mm -5'0"	kg lb	*4750 *10,700	*4750 *10,700	*7900 *17,150	7350 15,750	*5550 *11,950	4000 8,550	*3900 *8,350	2700 5,800	*3400 *7,450	2450 5,450	6440 21'0"
-3000 mm -10'0"	kg lb	*7300 *15,650	*7300 *15,650	*5750 *12,350	*5750 *12,350	*4150 *8,750	4000 8,650			*2950 *6,400	*2950 *6,400	5460 17'9"



ISO 10567



\* Indicates that the load is limited by hydraulic lifting capacity rather than tipping load. The above loads are in compliance with hydraulic excavator lift capacity standard ISO 10567:2007.

They do not exceed 87% of hydraulic lifting capacity or 75% of tipping load. Weight of all lifting accessories must be deducted from the above lifting capacities. Lifting capacities are based on the machine standing on a firm, uniform supporting surface. The use of a work tool attachment point to handle/lift objects, could affect the machine lift performance.

Lift capacity stays with ±5% for all available track shoes.

Always refer to the appropriate Operation and Maintenance Manual for specific product information.

# 315 GC Hydraulic Excavator Specifications

## Reach Boom Lift Capacities – Counterweight: 3.83 mt (8,440 lb) – without Bucket – Blade Up

2500 mm (8'2") Blade

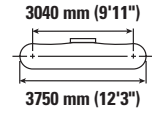
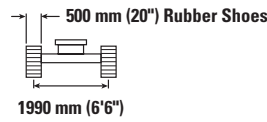
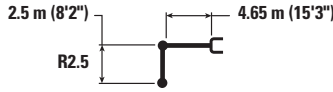

Reach Boom Length	Unit	1500 mm (5'0")		3000 mm (10'0")		4500 mm (15'0")		6000 mm (20'0")		2500 mm (8'2") Blade		mm ft/in
		ISO 10567	ISO 10567	ISO 10567	ISO 10567	ISO 10567	ISO 10567	ISO 10567	ISO 10567	ISO 10567	ISO 10567	
7500 mm 25'0"	kg lb			*4350 *9,200	*4350 *9,200					*3250 *7,450	*3250 *7,450	3710 11'5"
6000 mm 20'0"	kg lb					*4050 *8,750	*4050 *8,750			*2600 *5,800	*2600 *5,800	5490 17'8"
4500 mm 15'0"	kg lb			*4150 *9,050	*4150 *9,050	*4500 *9,750	4250 9,150	*3700 *7,600	2700 5,800	*2450 *5,350	2400 5,300	6460 21'0"
3000 mm 10'0"	kg lb			*7400 *15,850	*7400 *15,850	*5150 *11,150	4050 8,700	3900 8,400	2650 5,650	*2450 *5,350	2100 4,600	6970 22'9"
1500 mm 5'0"	kg lb			*6800 *16,700	6750 14,550	*5850 *12,600	3800 8,150	3800 8,150	2550 5,450	*2550 *5,600	1950 4,300	7130 23'4"
0 mm 0'0"	kg lb			*6250 *14,500	*6250 13,900	5700 12,200	3600 7,750	3700 7,950	2450 5,250	*2850 *6,250	2000 4,400	6960 22'9"
-1500 mm -5'0"	kg lb	*4750 *10,700	*4750 *10,700	*7900 *17,150	6450 13,800	*5550 *11,950	3550 7,600	3650 7,900	2400 5,200	3350 7,350	2200 4,850	6440 21'0"
-3000 mm -10'0"	kg lb	*7300 *15,650	*7300 *15,650	*5750 *12,350	*5750 *12,350	*4150 *8,750	3600 7,700			*2950 *6,400	2800 6,200	5460 17'9"

## Reach Boom Lift Capacities – Counterweight: 3.83 mt (8,440 lb) – without Bucket – Blade Down

2500 mm (8'2") Blade

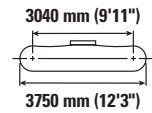
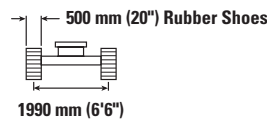
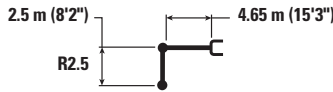

Reach Boom Length	Unit	1500 mm (5'0")		3000 mm (10'0")		4500 mm (15'0")		6000 mm (20'0")		2500 mm (8'2") Blade		mm ft/in
		ISO 10567	ISO 10567	ISO 10567	ISO 10567	ISO 10567	ISO 10567	ISO 10567	ISO 10567	ISO 10567	ISO 10567	
7500 mm 25'0"	kg lb			*4350 *9,200	*4350 *9,200					*3250 *7,450	*3250 *7,450	3710 11'5"
6000 mm 20'0"	kg lb					*4050 *8,750	*4050 *8,750			*2600 *5,800	*2600 *5,800	5490 17'8"
4500 mm 15'0"	kg lb			*4150 *9,050	*4150 *9,050	*4500 *9,750	*4500 *9,750	*3700 *7,600	2950 6,300	*2450 *5,350	*2450 *5,350	6460 21'0"
3000 mm 10'0"	kg lb			*7400 *15,850	*7400 *15,850	*5150 *11,150	4400 9,450	*4150 *9,050	2850 6,150	*2450 *5,350	2250 5,000	6970 22'9"
1500 mm 5'0"	kg lb			*6800 *16,700	*6800 16,150	*5850 *12,600	4150 8,900	*4400 *9,500	2750 5,900	*2550 *5,600	2150 4,700	7130 23'4"
0 mm 0'0"	kg lb			*6250 *14,500	*6250 *14,500	*6050 *13,050	3950 8,500	*4400 *9,500	2650 5,700	*2850 *6,250	2200 4,750	6960 22'9"
-1500 mm -5'0"	kg lb	*4750 *10,700	*4750 *10,700	*7900 *17,150	7150 15,350	*5550 *11,950	3900 8,350	*3900 *8,350	2650 5,650	*3400 *7,450	2400 5,300	6440 21'0"
-3000 mm -10'0"	kg lb	*7300 *15,650	*7300 *15,650	*5750 *12,350	*5750 *12,350	*4150 *8,750	3900 8,450			*2950 *6,400	*2950 *6,400	5460 17'9"



ISO 10567



\* Indicates that the load is limited by hydraulic lifting capacity rather than tipping load. The above loads are in compliance with hydraulic excavator lift capacity standard ISO 10567:2007.

They do not exceed 87% of hydraulic lifting capacity or 75% of tipping load. Weight of all lifting accessories must be deducted from the above lifting capacities. Lifting capacities are based on the machine standing on a firm, uniform supporting surface. The use of a work tool attachment point to handle/lift objects, could affect the machine lift performance.

Lift capacity stays with ±5% for all available track shoes.

Always refer to the appropriate Operation and Maintenance Manual for specific product information.









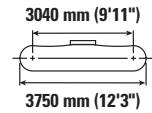
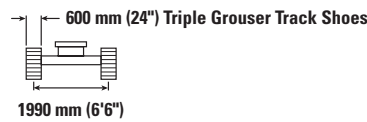
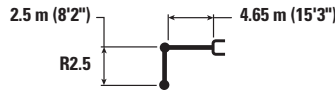



# 315 GC Hydraulic Excavator Specifications

## Reach Boom Lift Capacities – Counterweight: 3.83 mt (8,440 lb) – without Bucket – Blade Up

2600 mm (8'6") Blade









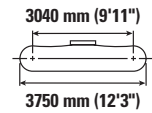
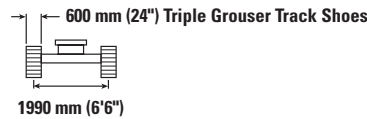



		1500 mm (5'0")		3000 mm (10'0")		4500 mm (15'0")		6000 mm (20'0")				mm ft/in
												
7500 mm 25'0"	kg lb			*4350 *9,200	*4350 *9,200					*3250 *7,450	*3250 *7,450	3710 11'5"
6000 mm 20'0"	kg lb					*4050 *8,750	*4050 *8,750			*2600 *5,800	*2600 *5,800	5490 17'8"
4500 mm 15'0"	kg lb			*4150 *9,050	*4150 *9,050	*4500 *9,750	4300 9,250	*3700 *7,600	2750 5,850	*2450 *5,350	2450 *5,350	6460 21'0"
3000 mm 10'0"	kg lb			*7400 *15,850	*7400 *15,850	*5150 *11,150	4100 8,800	3950 8,500	2650 5,700	*2450 *5,350	2100 4,650	6970 22'9"
1500 mm 5'0"	kg lb			*6800 *16,700	*6800 *16,700	*5850 *12,600	3850 8,250	3850 8,250	2550 5,500	*2550 *5,600	2000 4,400	7130 23'4"
0 mm 0'0"	kg lb			*6250 *14,500	*6250 *14,500	5750 12,300	3650 7,850	3750 8,050	2500 5,300	*2850 *6,250	2050 4,450	6960 22'9"
-1500 mm -5'0"	kg lb	*4750 *10,700	*4750 *10,700	*7900 *17,150	6500 14,000	*5550 *11,950	3600 7,700	3700 7,950	2450 5,250	3350 7,400	2250 4,900	6440 21'0"
-3000 mm -10'0"	kg lb	*7300 *15,650	*7300 *15,650	*5750 *12,350	*5750 *12,350	*4150 *8,750	3650 7,800			*2950 *6,400	2800 6,250	5460 17'9"

## Reach Boom Lift Capacities – Counterweight: 3.83 mt (8,440 lb) – without Bucket – Blade Down

2600 mm (8'6") Blade



		1500 mm (5'0")		3000 mm (10'0")		4500 mm (15'0")		6000 mm (20'0")				mm ft/in
												
7500 mm 25'0"	kg lb			*4350 *9,200	*4350 *9,200					*3250 *7,450	*3250 *7,450	3710 11'5"
6000 mm 20'0"	kg lb					*4050 *8,750	*4050 *8,750			*2600 *5,800	*2600 *5,800	5490 17'8"
4500 mm 15'0"	kg lb			*4150 *9,050	*4150 *9,050	*4500 *9,750	*4500 *9,750	*3700 *7,600	3050 6,500	*2450 *5,350	*2450 *5,350	6460 21'0"
3000 mm 10'0"	kg lb			*7400 *15,850	*7400 *15,850	*5150 *11,150	4550 9,750	*4150 *9,050	2950 6,350	*2450 *5,350	2350 5,150	6970 22'9"
1500 mm 5'0"	kg lb			*6800 *16,700	*6800 *16,700	*5850 *12,600	4300 9,200	*4400 *9,500	2850 6,100	*2550 *5,600	2200 4,850	7130 23'4"
0 mm 0'0"	kg lb			*6250 *14,500	*6250 *14,500	*6050 *13,050	4100 8,800	*4400 *9,500	2750 5,950	*2850 *6,250	2250 4,950	6960 22'9"
-1500 mm -5'0"	kg lb	*4750 *10,700	*4750 *10,700	*7900 *17,150	7450 16,000	*5550 *11,950	4050 8,650	*3900 *8,350	2750 5,850	*3400 *7,450	2500 5,500	6440 21'0"
-3000 mm -10'0"	kg lb	*7300 *15,650	*7300 *15,650	*5750 *12,350	*5750 *12,350	*4150 *8,750	4050 8,750			*2950 *6,400	*2950 *6,400	5460 17'9"



ISO 10567



\* Indicates that the load is limited by hydraulic lifting capacity rather than tipping load. The above loads are in compliance with hydraulic excavator lift capacity standard ISO 10567:2007.

They do not exceed 87% of hydraulic lifting capacity or 75% of tipping load. Weight of all lifting accessories must be deducted from the above lifting capacities. Lifting capacities are based on the machine standing on a firm, uniform supporting surface. The use of a work tool attachment point to handle/lift objects, could affect the machine lift performance.

Lift capacity stays with ±5% for all available track shoes.









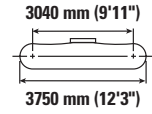
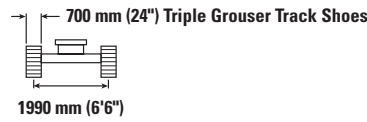
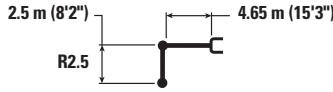

Always refer to the appropriate Operation and Maintenance Manual for specific product information.

# 315 GC Hydraulic Excavator Specifications

## Reach Boom Lift Capacities – Counterweight: 3.83 mt (8,440 lb) – without Bucket – Blade Up

2700 mm (8'10") Blade









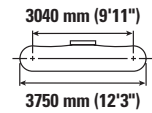
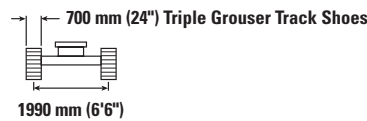
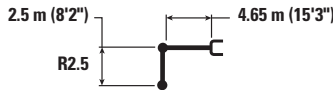



		1500 mm (5'0")		3000 mm (10'0")		4500 mm (15'0")		6000 mm (20'0")				mm ft/in
												
7500 mm 25'0"	kg lb			*4350 *9,200	*4350 *9,200					*3250 *7,450	*3250 *7,450	3710 11'5"
6000 mm 20'0"	kg lb					*4050 *8,750	*4050 *8,750			*2600 *5,800	*2600 *5,800	5490 17'8"
4500 mm 15'0"	kg lb			*4150 *9,050	*4150 *9,050	*4500 *9,750	4350 9,350	*3700 *7,600	2800 5,950	*2450 *5,350	*2450 *5,350	6460 21'0"
3000 mm 10'0"	kg lb			*7400 *15,850	*7400 *15,850	*5150 *11,150	4150 8,900	4000 8,600	2700 5,800	*2450 *5,350	2150 4,700	6970 22'9"
1500 mm 5'0"	kg lb			*6800 *16,700	*6800 *14,950	*5850 *12,600	3900 8,350	3900 8,350	2600 5,600	*2550 *5,600	2050 4,450	7130 23'4"
0 mm 0'0"	kg lb			*6250 *14,500	*6250 *14,250	5800 12,450	3700 7,950	3800 8,150	2500 5,400	*2850 *6,250	2050 4,500	6960 22'9"
-1500 mm -5'0"	kg lb	*4750 *10,700	*4750 *10,700	*7900 *17,150	6600 14,200	*5550 *11,950	3650 7,800	3750 8,050	2500 5,350	*3400 *7,450	2250 5,000	6440 21'0"
-3000 mm -10'0"	kg lb	*7300 *15,650	*7300 *15,650	*5750 *12,350	*5750 *12,350	*4150 *8,750	3700 7,900			*2950 *6,400	2850 6,350	5460 17'9"

## Reach Boom Lift Capacities – Counterweight: 3.83 mt (8,440 lb) – without Bucket – Blade Down

2700 mm (8'10") Blade



		1500 mm (5'0")		3000 mm (10'0")		4500 mm (15'0")		6000 mm (20'0")				mm ft/in
												
7500 mm 25'0"	kg lb			*4350 *9,200	*4350 *9,200					*3250 *7,450	*3250 *7,450	3710 11'5"
6000 mm 20'0"	kg lb					*4050 *8,750	*4050 *8,750			*2600 *5,800	*2600 *5,800	5490 17'8"
4500 mm 15'0"	kg lb			*4150 *9,050	*4150 *9,050	*4500 *9,750	*4500 *9,750	*3700 *7,600	3150 6,700	*2450 *5,350	*2450 *5,350	6460 21'0"
3000 mm 10'0"	kg lb			*7400 *15,850	*7400 *15,850	*5150 *11,150	4700 10,100	*4150 *9,050	3050 6,550	*2450 *5,350	2450 *5,350	6970 22'9"
1500 mm 5'0"	kg lb			*6800 *16,700	*6800 *16,700	*5850 *12,600	4450 9,550	*4400 *9,500	2950 6,350	*2550 *5,600	2300 5,050	7130 23'4"
0 mm 0'0"	kg lb			*6250 *14,500	*6250 *14,500	*6050 *13,050	4250 9,150	*4400 *9,500	2850 6,150	*2850 *6,250	2350 5,150	6960 22'9"
-1500 mm -5'0"	kg lb	*4750 *10,700	*4750 *10,700	*7900 *17,150	7800 16,650	*5550 *11,950	4200 9,000	*3900 *8,350	2850 6,100	*3400 *7,450	2600 5,700	6440 21'0"
-3000 mm -10'0"	kg lb	*7300 *15,650	*7300 *15,650	*5750 *12,350	*5750 *12,350	*4150 *8,750	*4150 *8,750			*2950 *6,400	*2950 *6,400	5460 17'9"



ISO 10567



\* Indicates that the load is limited by hydraulic lifting capacity rather than tipping load. The above loads are in compliance with hydraulic excavator lift capacity standard ISO 10567:2007.

They do not exceed 87% of hydraulic lifting capacity or 75% of tipping load. Weight of all lifting accessories must be deducted from the above lifting capacities. Lifting capacities are based on the machine standing on a firm, uniform supporting surface. The use of a work tool attachment point to handle/lift objects, could affect the machine lift performance.

Lift capacity stays with ±5% for all available track shoes.

Always refer to the appropriate Operation and Maintenance Manual for specific product information.

# 315 GC Hydraulic Excavator Specifications

## Reach Boom Lift Capacities – Counterweight: 3.83 mt (8,440 lb) – without Bucket – Blade Up

2500 mm (8'2") Blade

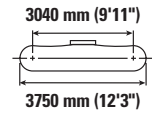
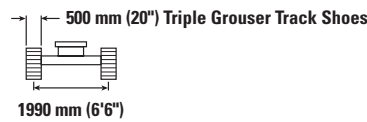
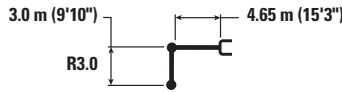

		1500 mm (5'0")		3000 mm (10'0")		4500 mm (15'0")		6000 mm (20'0")		7500 mm (25'0")		mm ft/in		
7500 mm 25'0"	kg lb					*2700	*2700					*2600 *5,850	*2600 *5,850	4540 14'3"
6000 mm 20'0"	kg lb					*3450 *7,550	*3450 *7,550	*2400	*2400			*2200 *4,850	*2200 *4,850	6070 19'8"
4500 mm 15'0"	kg lb					*3650 *7,950	*3650 *7,950	*3450 *7,400	2700 5,850			*2050 *4,500	*2050 *4,500	6960 22'8"
3000 mm 10'0"	kg lb			*5850 *12,100	*5850 *12,100	*4800 *10,350	4100 8,750	3900 8,400	2650 5,650			*2050 *4,500	1850 4,100	7440 24'4"
1500 mm 5'0"	kg lb			*8750 *18,800	6900 14,800	*5600 *12,050	3800 8,150	3800 8,100	2500 5,400	*2500	1800	*2150 *4,750	1750 3,850	7590 24'10"
0 mm 0'0"	kg lb			*7000 *16,150	6450 13,800	5650 12,100	3600 7,700	3650 7,850	2400 5,150			*2400 *5,250	1800 3,900	7430 24'4"
-1500 mm -5'0"	kg lb	*4300 *9,650	*4300 *9,650	*8500 *18,350	6300 13,550	5500 11,850	3450 7,450	3600 7,750	2350 5,050			*2850 *6,250	1950 4,250	6940 22'8"
-3000 mm -10'0"	kg lb	*7450 *16,700	*7450 *16,700	*6650 *14,350	6350 13,650	*4700 *10,000	3450 7,450	*3000	2350			*2950 *6,400	2350 5,200	6050 19'8"
-4500 mm -15'0"	kg lb			*3450 *7,050	*3450 *7,050							*2050 *4,250	*2050 *4,250	4490 14'4"

## Reach Boom Lift Capacities – Counterweight: 3.83 mt (8,440 lb) – without Bucket – Blade Down

2500 mm (8'2") Blade

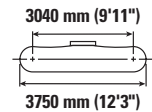
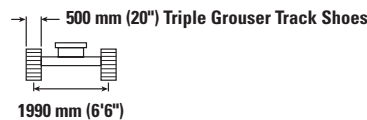
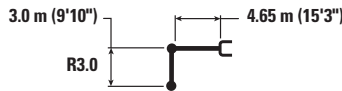

		1500 mm (5'0")		3000 mm (10'0")		4500 mm (15'0")		6000 mm (20'0")		7500 mm (25'0")		mm ft/in		
7500 mm 25'0"	kg lb					*2700	*2700					*2600 *5,850	*2600 *5,850	4540 14'3"
6000 mm 20'0"	kg lb					*3450 *7,550	*3450 *7,550	*2400	*2400			*2200 *4,850	*2200 *4,850	6070 19'8"
4500 mm 15'0"	kg lb					*3650 *7,950	*3650 *7,950	*3450 *7,400	2950 6,300			*2050 *4,500	*2050 *4,500	6960 22'8"
3000 mm 10'0"	kg lb			*5850 *12,100	*5850 *12,100	*4800 *10,350	4450 9,500	*3950 *8,550	2850 6,150			*2050 *4,500	2050 4,450	7440 24'4"
1500 mm 5'0"	kg lb			*8750 *18,800	7650 16,400	*5600 *12,050	4150 8,900	*4250 *9,200	2750 5,850	*2500	1950	*2150 *4,750	1950 4,200	7590 24'10"
0 mm 0'0"	kg lb			*7000 *16,150	*7000 15,350	*6000 *12,950	3900 8,400	*4400 *9,500	2600 5,650			*2400 *5,250	1950 4,250	7430 24'4"
-1500 mm -5'0"	kg lb	*4300 *9,650	*4300 *9,650	*8500 *18,350	7050 15,050	*5750 *12,400	3800 8,200	*4100 *8,850	2550 5,500			*2850 *6,250	2100 4,650	6940 22'8"
-3000 mm -10'0"	kg lb	*7450 *16,700	*7450 *16,700	*6650 *14,350	*6650 *14,350	*4700 *10,000	3800 8,200	*3000	2600			*2950 *6,400	2550 5,700	6050 19'8"
-4500 mm -15'0"	kg lb			*3450 *7,050	*3450 *7,050							*2050 *4,250	*2050 *4,250	4490 14'4"



ISO 10567



\* Indicates that the load is limited by hydraulic lifting capacity rather than tipping load. The above loads are in compliance with hydraulic excavator lift capacity standard ISO 10567:2007. They do not exceed 87% of hydraulic lifting capacity or 75% of tipping load. Weight of all lifting accessories must be deducted from the above lifting capacities. Lifting capacities are based on the machine standing on a firm, uniform supporting surface. The use of a work tool attachment point to handle/lift objects, could affect the machine lift performance.

Lift capacity stays with ±5% for all available track shoes.

Always refer to the appropriate Operation and Maintenance Manual for specific product information.

# 315 GC Hydraulic Excavator Specifications

## Reach Boom Lift Capacities – Counterweight: 3.83 mt (8,440 lb) – without Bucket – Blade Up

2500 mm (8'2") Blade

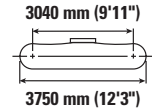
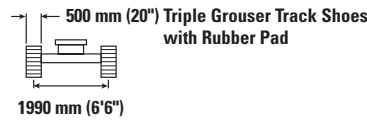
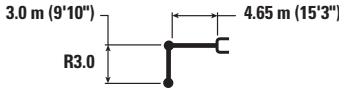

		1500 mm (5'0")		3000 mm (10'0")		4500 mm (15'0")		6000 mm (20'0")		7500 mm (25'0")		mm ft/in		
7500 mm 25'0"	kg lb					*2700	*2700					*2600 *5,850	*2600 *5,850	4540 14'3"
6000 mm 20'0"	kg lb					*3450 *7,550	*3450 *7,550	*2400	*2400			*2200 *4,850	*2200 *4,850	6070 19'8"
4500 mm 15'0"	kg lb					*3650 *7,950	*3650 *7,950	*3450 *7,400	2800 6,000			*2050 *4,500	*2050 *4,500	6960 22'8"
3000 mm 10'0"	kg lb			*5850 *12,100	*5850 *12,100	*4800 *10,350	4200 9,000	*3950 *8,550	2700 5,850			*2050 *4,500	1950 4,250	7440 24'4"
1500 mm 5'0"	kg lb			*8750 *18,800	7100 15,250	*5600 *12,050	3900 8,400	3900 8,400	2600 5,550	*2500	1850	*2150 *4,750	1850 4,000	7590 24'10"
0 mm 0'0"	kg lb			*7000 *16,150	6650 14,250	5850 12,550	3700 7,950	3800 8,150	2500 5,350			*2400 *5,250	1850 4,050	7430 24'4"
-1500 mm -5'0"	kg lb	*4300 *9,650	*4300 *9,650	*8500 *18,350	6500 14,000	5700 12,250	3600 7,700	3750 8,000	2450 5,200			*2850 *6,250	2000 4,400	6940 22'8"
-3000 mm -10'0"	kg lb	*7450 *16,700	*7450 *16,700	*6650 *14,350	6600 14,100	*4700 *10,000	3600 7,700	*3000	2450			*2950 *6,400	2450 5,400	6050 19'8"
-4500 mm -15'0"	kg lb			*3450 *7,050	*3450 *7,050							*2050 *4,250	*2050 *4,250	4490 14'4"

## Reach Boom Lift Capacities – Counterweight: 3.83 mt (8,440 lb) – without Bucket – Blade Down

2500 mm (8'2") Blade

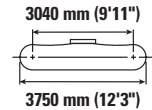
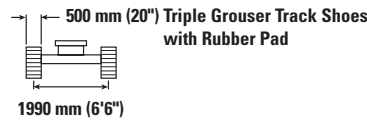
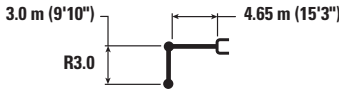

		1500 mm (5'0")		3000 mm (10'0")		4500 mm (15'0")		6000 mm (20'0")		7500 mm (25'0")		mm ft/in		
7500 mm 25'0"	kg lb					*2700	*2700					*2600 *5,850	*2600 *5,850	4540 14'3"
6000 mm 20'0"	kg lb					*3450 *7,550	*3450 *7,550	*2400	*2400			*2200 *4,850	*2200 *4,850	6070 19'8"
4500 mm 15'0"	kg lb					*3650 *7,950	*3650 *7,950	*3450 *7,400	3050 6,500			*2050 *4,500	*2050 *4,500	6960 22'8"
3000 mm 10'0"	kg lb			*5850 *12,100	*5850 *12,100	*4800 *10,350	4550 9,800	*3950 *8,550	2950 6,300			*2050 *4,500	*2050 *4,500	7440 24'4"
1500 mm 5'0"	kg lb			*8750 *18,800	7850 16,900	*5600 *12,050	4250 9,200	*4250 *9,200	2800 6,050	*2500	2050	*2150 *4,750	2000 4,350	7590 24'10"
0 mm 0'0"	kg lb			*7000 *16,150	*7000 *15,850	*6000 *12,950	4050 8,700	*4400 *9,500	2700 5,850			*2400 *5,250	2000 4,400	7430 24'4"
-1500 mm -5'0"	kg lb	*4300 *9,650	*4300 *9,650	*8500 *18,350	7250 15,550	*5750 *12,400	3950 8,450	*4100 *8,850	2650 5,700			*2850 *6,250	2200 4,800	6940 22'8"
-3000 mm -10'0"	kg lb	*7450 *16,700	*7450 *16,700	*6650 *14,350	*6650 *14,350	*4700 *10,000	3650 8,450	*3000	2700			*2950 *6,400	2650 5,900	6050 19'8"
-4500 mm -15'0"	kg lb			*3450 *7,050	*3450 *7,050							*2050 *4,250	*2050 *4,250	4490 14'4"



ISO 10567



\* Indicates that the load is limited by hydraulic lifting capacity rather than tipping load. The above loads are in compliance with hydraulic excavator lift capacity standard ISO 10567:2007. They do not exceed 87% of hydraulic lifting capacity or 75% of tipping load. Weight of all lifting accessories must be deducted from the above lifting capacities. Lifting capacities are based on the machine standing on a firm, uniform supporting surface. The use of a work tool attachment point to handle/lift objects, could affect the machine lift performance.

Lift capacity stays with ±5% for all available track shoes.

Always refer to the appropriate Operation and Maintenance Manual for specific product information.

# 315 GC Hydraulic Excavator Specifications

## Reach Boom Lift Capacities – Counterweight: 3.83 mt (8,440 lb) – without Bucket – Blade Up

2500 mm (8'2") Blade

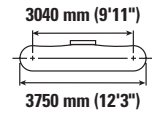
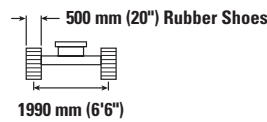
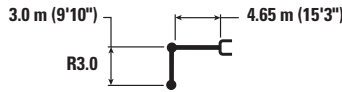

		1500 mm (5'0")		3000 mm (10'0")		4500 mm (15'0")		6000 mm (20'0")		7500 mm (25'0")		mm ft/in		
7500 mm 25'0"	kg lb					*2700	*2700					*2600 *5,850	*2600 *5,850	4540 14'3"
6000 mm 20'0"	kg lb					*3450 *7,550	*3450 *7,550	*2400	*2400			*2200 *4,850	*2200 *4,850	6070 19'8"
4500 mm 15'0"	kg lb					*3650 *7,950	*3650 *7,950	*3450 *7,400	2750 5,900			*2050 *4,500	*2050 *4,500	6960 22'8"
3000 mm 10'0"	kg lb			*5850 *12,100	*5850 *12,100	*4800 *10,350	4100 8,850	*3950 8,450	2650 5,700			*2050 *4,500	1900 4,150	7440 24'4"
1500 mm 5'0"	kg lb			*8750 *18,800	6950 14,950	*5600 *12,050	3850 8,250	3800 8,200	2550 5,450	*2500 1800		*2150 *4,750	1800 3,900	7590 24'10"
0 mm 0'0"	kg lb			*7000 *16,150	6500 13,900	5700 12,200	3600 7,750	3700 7,950	2450 5,200			*2400 *5,250	1800 3,950	7430 24'4"
-1500 mm -5'0"	kg lb	*4300 *9,650	*4300 *9,650	*8500 *18,350	6350 13,650	5550 11,950	3500 7,500	3650 7,800	2350 5,100			*2850 *6,250	1950 4,300	6940 22'8"
-3000 mm -10'0"	kg lb	*7450 *16,700	*7450 *16,700	*6650 *14,350	6400 13,750	*4700 *10,000	3500 7,550	*3000	2400			*2950 *6,400	2400 5,250	6050 19'8"
-4500 mm -15'0"	kg lb			*3450 *7,050	*3450 *7,050							*2050 *4,250	*2050 *4,250	4490 14'4"

## Reach Boom Lift Capacities – Counterweight: 3.83 mt (8,440 lb) – without Bucket – Blade Down

2500 mm (8'2") Blade

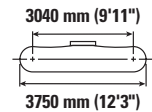
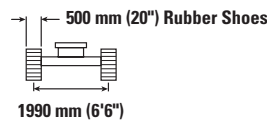
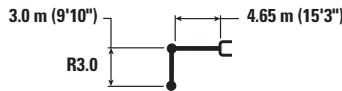

		1500 mm (5'0")		3000 mm (10'0")		4500 mm (15'0")		6000 mm (20'0")		7500 mm (25'0")		mm ft/in		
7500 mm 25'0"	kg lb					*2700	*2700					*2600 *5,850	*2600 *5,850	4540 14'3"
6000 mm 20'0"	kg lb					*3450 *7,550	*3450 *7,550	*2400	*2400			*2200 *4,850	*2200 *4,850	6070 19'8"
4500 mm 15'0"	kg lb					*3650 *7,950	*3650 *7,950	*3450 *7,400	2950 6,350			*2050 *4,500	*2050 *4,500	6960 22'8"
3000 mm 10'0"	kg lb			*5850 *12,100	*5850 *12,100	*4800 *10,350	4450 9,600	*3950 *8,550	2900 6,150			*2050 *4,500	2050 4,500	7440 24'4"
1500 mm 5'0"	kg lb			*8750 *18,800	7700 16,500	*5600 *12,050	4200 9,000	*4250 *9,200	2750 5,900	*2500 2000		*2150 *4,750	1950 4,250	7590 24'10"
0 mm 0'0"	kg lb			*7000 *16,150	*7000 15,450	*6000 *12,950	3950 8,500	*4400 *9,500	2650 5,700			*2400 *5,250	1950 4,300	7430 24'4"
-1500 mm -5'0"	kg lb	*4300 *9,650	*4300 *9,650	*8500 *18,350	7100 15,200	*5750 *12,400	3850 8,250	*4100 *8,850	2600 5,550			*2850 *6,250	2150 4,700	6940 22'8"
-3000 mm -10'0"	kg lb	*7450 *16,700	*7450 *16,700	*6650 *14,350	*6650 *14,350	*4700 *10,000	3850 8,250	*3000	2600			*2950 *6,400	2600 5,750	6050 19'8"
-4500 mm -15'0"	kg lb			*3450 *7,050	*3450 *7,050							*2050 *4,250	*2050 *4,250	4490 14'4"



ISO 10567



\* Indicates that the load is limited by hydraulic lifting capacity rather than tipping load. The above loads are in compliance with hydraulic excavator lift capacity standard ISO 10567:2007. They do not exceed 87% of hydraulic lifting capacity or 75% of tipping load. Weight of all lifting accessories must be deducted from the above lifting capacities. Lifting capacities are based on the machine standing on a firm, uniform supporting surface. The use of a work tool attachment point to handle/lift objects, could affect the machine lift performance.

Lift capacity stays with ±5% for all available track shoes.

Always refer to the appropriate Operation and Maintenance Manual for specific product information.

# 315 GC Hydraulic Excavator Specifications

## Reach Boom Lift Capacities – Counterweight: 3.83 mt (8,440 lb) – without Bucket – Blade Up

2600 mm (8'6") Blade

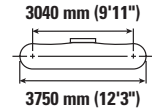
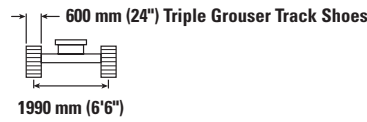
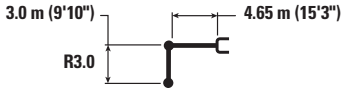

		1500 mm (5'0")		3000 mm (10'0")		4500 mm (15'0")		6000 mm (20'0")		7500 mm (25'0")		mm ft/in		
7500 mm 25'0"	kg lb					*2700	*2700					*2600 *5,850	*2600 *5,850	4540 14'3"
6000 mm 20'0"	kg lb					*3450 *7,550	*3450 *7,550	*2400	*2400			*2200 *4,850	*2200 *4,850	6070 19'8"
4500 mm 15'0"	kg lb					*3650 *7,950	*3650 *7,950	*3450 *7,400	2800 5,950			*2050 *4,500	*2050 *4,500	6960 22'8"
3000 mm 10'0"	kg lb			*5850 *12,100	*5850 *12,100	*4800 *10,350	4150 8,950	*3950 8,550	2700 5,750			*2050 *4,500	1900 4,200	7440 24'4"
1500 mm 5'0"	kg lb			*8750 *18,800	7000 15,100	*5600 *12,050	3850 8,350	3850 8,250	2550 5,500	*2500 1850		*2150 *4,750	1800 3,950	7590 24'10"
0 mm 0'0"	kg lb			*7000 *16,150	6550 14,100	5750 12,300	3650 7,850	3750 8,000	2450 5,300			*2400 *5,250	1850 4,000	7430 24'4"
-1500 mm -5'0"	kg lb	*4300 *9,650	*4300 *9,650	*8500 *18,350	6450 13,800	5600 12,050	3550 7,600	3650 7,850	2400 5,150			*2850 *6,250	2000 4,350	6940 22'8"
-3000 mm -10'0"	kg lb	*7450 *16,700	*7450 *16,700	*6650 *14,350	6500 13,950	*4700 *10,000	3550 7,650	*3000	2450			*2950 *6,400	2400 5,300	6050 19'8"
-4500 mm -15'0"	kg lb			*3450 *7,050	*3450 *7,050							*2050 *4,250	*2050 *4,250	4490 14'4"

## Reach Boom Lift Capacities – Counterweight: 3.83 mt (8,440 lb) – without Bucket – Blade Down

2600 mm (8'6") Blade

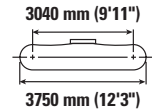
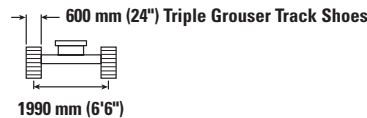
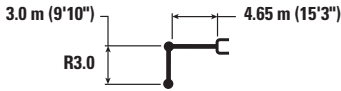

		1500 mm (5'0")		3000 mm (10'0")		4500 mm (15'0")		6000 mm (20'0")		7500 mm (25'0")		mm ft/in		
7500 mm 25'0"	kg lb					*2700	*2700					*2600 *5,850	*2600 *5,850	4540 14'3"
6000 mm 20'0"	kg lb					*3450 *7,550	*3450 *7,550	*2400	*2400			*2200 *4,850	*2200 *4,850	6070 19'8"
4500 mm 15'0"	kg lb					*3650 *7,950	*3650 *7,950	*3450 *7,400	3050 6,550			*2050 *4,500	*2050 *4,500	6960 22'8"
3000 mm 10'0"	kg lb			*5850 *12,100	*5850 *12,100	*4800 *10,350	4600 9,900	*3950 8,550	3000 6,400			*2050 *4,500	*2050 *4,500	7440 24'4"
1500 mm 5'0"	kg lb			*8750 *18,800	8000 17,150	*5600 *12,050	4300 9,300	*4250 *9,200	2850 6,100	*2500 2050		*2150 *4,750	2000 4,400	7590 24'10"
0 mm 0'0"	kg lb			*7000 *16,150	7000 16,100	*6000 *12,950	4100 8,800	*4400 *9,500	2750 5,900			*2400 *5,250	2050 4,450	7430 24'4"
-1500 mm -5'0"	kg lb	*4300 *9,650	*4300 *9,650	*8500 *18,350	7400 15,850	*5750 *12,400	4000 8,550	*4100 *8,850	2700 5,750			*2850 *6,250	2200 4,850	6940 22'8"
-3000 mm -10'0"	kg lb	*7450 *16,700	*7450 *16,700	*6650 *14,350	*6650 *14,350	*4700 *10,000	4000 8,600	*3000	2700			*2950 *6,400	2700 5,950	6050 19'8"
-4500 mm -15'0"	kg lb			*3450 *7,050	*3450 *7,050							*2050 *4,250	*2050 *4,250	4490 14'4"



ISO 10567



\* Indicates that the load is limited by hydraulic lifting capacity rather than tipping load. The above loads are in compliance with hydraulic excavator lift capacity standard ISO 10567:2007. They do not exceed 87% of hydraulic lifting capacity or 75% of tipping load. Weight of all lifting accessories must be deducted from the above lifting capacities. Lifting capacities are based on the machine standing on a firm, uniform supporting surface. The use of a work tool attachment point to handle/lift objects, could affect the machine lift performance.

Lift capacity stays with ±5% for all available track shoes.

Always refer to the appropriate Operation and Maintenance Manual for specific product information.

# 315 GC Hydraulic Excavator Specifications

## Reach Boom Lift Capacities – Counterweight: 3.83 mt (8,440 lb) – without Bucket – Blade Up

2700 mm (8'10") Blade

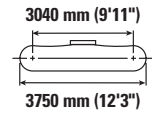
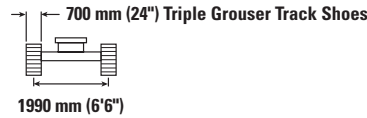
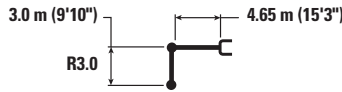

		1500 mm (5'0")		3000 mm (10'0")		4500 mm (15'0")		6000 mm (20'0")		7500 mm (25'0")		mm ft/in		
7500 mm 25'0"	kg lb					*2700	*2700					*2600 *5,850	*2600 *5,850	4540 14'3"
6000 mm 20'0"	kg lb					*3450 *7,550	*3450 *7,550	*2400	*2400			*2200 *4,850	*2200 *4,850	6070 19'8"
4500 mm 15'0"	kg lb					*3650 *7,950	*3650 *7,950	*3450 *7,400	2800 6,000			*2050 *4,500	*2050 *4,500	6960 22'8"
3000 mm 10'0"	kg lb			*5850 *12,100	*5850 *12,100	*4800 *10,350	4200 9,050	*3950 *8,550	2700 5,850			*2050 *4,500	1950 4,250	7440 24'4"
1500 mm 5'0"	kg lb			*8750 *18,800	7100 15,300	*5600 *12,050	3900 8,450	3900 8,350	2600 5,600	*2500 1850		*2150 *4,750	1850 4,000	7590 24'10"
0 mm 0'0"	kg lb			*7000 *16,150	6650 14,300	5800 12,500	3700 7,950	3800 8,100	2500 5,350			*2400 *5,250	1850 4,050	7430 24'4"
-1500 mm -5'0"	kg lb	*4300 *9,650	*4300 *9,650	*8500 *18,350	6550 14,000	5700 12,200	3600 7,750	3700 7,950	2450 5,250			*2850 *6,250	2000 4,400	6940 22'8"
-3000 mm -10'0"	kg lb	*7450 *16,700	*7450 *16,700	*6650 *14,350	6600 14,150	*4700 *10,000	3600 7,750	*3000	2450			*2950 *6,400	2450 5,400	6050 19'8"
-4500 mm -15'0"	kg lb			*3450 *7,050	*3450 *7,050							*2050 *4,250	*2050 *4,250	4490 14'4"

## Reach Boom Lift Capacities – Counterweight: 3.83 mt (8,440 lb) – without Bucket – Blade Down

2700 mm (8'10") Blade

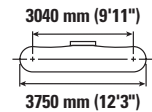
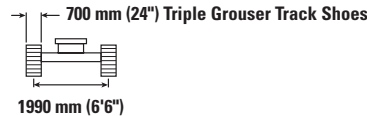
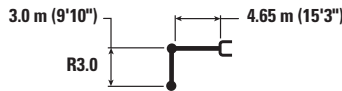

		1500 mm (5'0")		3000 mm (10'0")		4500 mm (15'0")		6000 mm (20'0")		7500 mm (25'0")		mm ft/in		
7500 mm 25'0"	kg lb					*2700	*2700					*2600 *5,850	*2600 *5,850	4540 14'3"
6000 mm 20'0"	kg lb					*3450 *7,550	*3450 *7,550	*2400	*2400			*2200 *4,850	*2200 *4,850	6070 19'8"
4500 mm 15'0"	kg lb					*3650 *7,950	*3650 *7,950	*3450 *7,400	3150 6,800			*2050 *4,500	*2050 *4,500	6960 22'8"
3000 mm 10'0"	kg lb			*5850 *12,100	*5850 *12,100	*4800 *10,350	4750 10,250	*3950 *8,550	3100 6,600			*2050 *4,500	*2050 *4,500	7440 24'4"
1500 mm 5'0"	kg lb			*8750 *18,800	8300 17,850	*5600 *12,050	4500 9,650	*4250 *9,200	2950 6,350	*2500 2100		*2150 *4,750	2100 4,550	7590 24'10"
0 mm 0'0"	kg lb			*7000 *16,150	*7000 *16,150	*6000 *12,950	4250 9,150	*4400 *9,500	2850 6,100			*2400 *5,250	2100 4,650	7430 24'4"
-1500 mm -5'0"	kg lb	*4300 *9,650	*4300 *9,650	*8500 *18,350	7700 16,500	*5750 *12,400	4150 8,900	*4100 *8,850	2800 6,000			*2850 *6,250	2300 5,050	6940 22'8"
-3000 mm -10'0"	kg lb	*7450 *16,700	*7450 *16,700	*6650 *14,350	*6650 *14,350	*4700 *10,000	4150 8,900	*3000	2800			*2950 *6,400	2800 6,150	6050 19'8"
-4500 mm -15'0"	kg lb			*3450 *7,050	*3450 *7,050							*2050 *4,250	*2050 *4,250	4490 14'4"



ISO 10567



\* Indicates that the load is limited by hydraulic lifting capacity rather than tipping load. The above loads are in compliance with hydraulic excavator lift capacity standard ISO 10567:2007. They do not exceed 87% of hydraulic lifting capacity or 75% of tipping load. Weight of all lifting accessories must be deducted from the above lifting capacities. Lifting capacities are based on the machine standing on a firm, uniform supporting surface. The use of a work tool attachment point to handle/lift objects, could affect the machine lift performance.

Lift capacity stays with ±5% for all available track shoes.

Always refer to the appropriate Operation and Maintenance Manual for specific product information.

# 315 GC Hydraulic Excavator Specifications

## Bucket Specifications and Compatibility

	Linkage	Width		Capacity		Weight		Fill %	Reach Boom	
		mm	in	m <sup>3</sup>	yd <sup>3</sup>	kg	lb		R2.5 (8'2")	R3.0 (9'10")
<b>Pin-On (No Quick Coupler)</b>										
General Duty	312	600	24	0.31	0.40	316	696	100	●	●
	312	900	36	0.53	0.69	414	914	100	●	●
	312	900	36	0.53	0.69	420	927	100	●	●
	312	1000	39	0.60	0.78	438	967	100	●	●
General Duty (No Adjuster)	312	450	18	0.20	0.26	266	587	100	●	●
	312	600	24	0.31	0.40	310	684	100	●	●
	312	750	30	0.41	0.54	358	790	100	●	●
	312	750	30	0.41	0.54	410	903	100	●	●
	312	900	36	0.53	0.69	407	898	100	●	●
	312	900	36	0.53	0.69	451	994	100	●	●
Heavy Duty	312	1050	42	0.65	0.84	457	1,006	100	●	⊙
	312	450	18	0.20	0.27	279	615	100	●	●
Ditch Cleaning	312	1200	48	0.76	0.99	513	1,131	100	⊙	⊖
Ditch Cleaning Tilt	312	1800	72	0.68	0.89	540	1,191	100	●	⊙
								kg	1930	1720
Maximum load with pin-on (payload + bucket)								lb	4,262	3,787
<b>With Cat Pin Grabber Coupler</b>										
General Duty	312	600	24	0.31	0.40	316	696	100	●	●
	312	900	36	0.53	0.69	414	914	100	●	●
	312	1100	43	0.68	0.89	474	1,045	100	⊙	⊖
	312	1200	48	0.76	1.00	504	1,110	100	⊖	○
General Duty (No Adjuster)	312	450	18	0.20	0.26	266	587	100	●	●
	312	600	24	0.31	0.40	310	684	100	●	●
	312	750	30	0.41	0.54	358	790	100	●	●
	312	750	30	0.41	0.54	410	903	100	●	●
	312	900	36	0.53	0.69	407	898	100	●	●
	312	900	36	0.53	0.69	451	994	100	●	●
	312	1050	42	0.65	0.84	457	1,006	100	⊙	⊖
	312	1200	48	0.76	1.00	497	1,095	100	⊖	○
Heavy Duty	312	450	18	0.20	0.27	279	615	100	●	●
	312	1200	48	0.76	0.99	513	1,131	100	⊖	○
Ditch Cleaning	312	1800	72	0.68	0.89	540	1,191	100	⊙	⊖
Ditch Cleaning Tilt	312	1800	72	0.60	0.78	724	1,597	100	⊖	○
								kg	1734	1518
Maximum load with coupler (payload + bucket)								lb	3,822	3,347

The above loads are in compliance with hydraulic excavator standard EN474-5:2006 + A3:2013, they do not exceed 87% of hydraulic lifting capacity or 75% of tipping capacity with front linkage fully extended at ground line with bucket curled. Capacity based on ISO 7451:2007.

**Maximum Material Density:**

- 2100 kg/m<sup>3</sup> (3,500 lb/yd<sup>3</sup>)
- ⊙ 1800 kg/m<sup>3</sup> (3,000 lb/yd<sup>3</sup>)
- ⊖ 1500 kg/m<sup>3</sup> (2,500 lb/yd<sup>3</sup>)
- 1200 kg/m<sup>3</sup> (2,000 lb/yd<sup>3</sup>)

Caterpillar recommends using appropriate work tools to maximize the value customers receive from our products. Use of work tools, including buckets, which are outside of Caterpillar's recommendations or specifications for weight, dimensions, flows, pressures, etc. may result in less-than-optimal performance, including but not limited to reductions in production, stability, reliability, and component durability. Improper use of a work tool resulting in sweeping, prying, twisting and/or catching of heavy loads will reduce the life of the boom and stick.

*(continued on next page)*



# 315 GC Hydraulic Excavator Specifications

## Bucket Specifications and Compatibility (continued)

	Linkage	Width		Capacity		Weight		Fill %	Reach Boom	
		mm	in	m <sup>3</sup>	yd <sup>3</sup>	kg	lb		R2.5 (8'2")	R3.0 (9'10")
<b>With CW20 Coupler</b>										
General Duty	312	600	24	0.31	0.40	341	752	100	●	●
	312	900	36	0.53	0.69	426	940	100	●	●
	312	1100	43	0.68	0.89	487	1,073	100	⊙	⊖
	312	1200	48	0.76	1.00	516	1,137	100	⊖	○
Heavy Duty	312	1200	48	0.76	1.00	526	1,159	100	⊖	○
General Duty – Leveling Edge	312	690	27	0.40	0.52	413	910	100	●	●
	312	600	24	0.33	0.43	395	870	100	●	●
	312	790	31	0.47	0.61	455	1,003	100	●	●
	312	996	39	0.63	0.83	517	1,140	100	⊙	⊖
	312	1184	47	0.80	1.05	603	1,328	100	○	◇
Ditch Cleaning	312	1800	72	0.68	0.89	516	1,138	100	⊙	⊖
	312	1800	72	0.90	1.18	554	1,221	100	○	◇
Maximum load with coupler (payload + bucket)								kg	1728	1513
								lb	3,810	3,335
<b>With CW20S Coupler</b>										
General Duty	312	450	18	0.20	0.26	301	664	100	●	●
	312	500	20	0.24	0.31	310	684	100	●	●
	312	600	24	0.31	0.40	329	726	100	●	●
	312	750	30	0.41	0.54	377	830	100	●	●
	312	900	36	0.53	0.69	426	940	100	●	●
	312	1000	39	0.60	0.78	451	995	100	●	⊙
	312	1100	43	0.68	0.89	487	1,073	100	⊙	⊖
	312	1200	48	0.76	1.00	516	1,137	100	⊖	○
Heavy Duty	312	500	20	0.24	0.31	313	689	100	●	●
	312	1200	48	0.76	1.00	524	1,154	100	⊖	○
Ditch Cleaning	312	1800	72	0.68	0.89	548	1,207	100	⊙	⊖
	312	2000	78	1.00	1.31	630	1,389	100	◇	◇
Ditch Cleaning Tilt	312	1800	72	0.60	0.78	822	1,812	100	⊖	○
Maximum load with coupler (payload + bucket)								kg	1750	1535
								lb	3,859	3,384

The above loads are in compliance with hydraulic excavator standard EN474-5:2006 + A3:2013, they do not exceed 87% of hydraulic lifting capacity or 75% of tipping capacity with front linkage fully extended at ground line with bucket curled. Capacity based on ISO 7451:2007.

### Maximum Material Density:

- 2100 kg/m<sup>3</sup> (3,500 lb/yd<sup>3</sup>)
- ⊙ 1800 kg/m<sup>3</sup> (3,000 lb/yd<sup>3</sup>)
- ⊖ 1500 kg/m<sup>3</sup> (2,500 lb/yd<sup>3</sup>)
- 1200 kg/m<sup>3</sup> (2,000 lb/yd<sup>3</sup>)
- ◇ 900 kg/m<sup>3</sup> (1,500 lb/yd<sup>3</sup>)

Caterpillar recommends using appropriate work tools to maximize the value customers receive from our products. Use of work tools, including buckets, which are outside of Caterpillar's recommendations or specifications for weight, dimensions, flows, pressures, etc. may result in less-than-optimal performance, including but not limited to reductions in production, stability, reliability, and component durability. Improper use of a work tool resulting in sweeping, prying, twisting and/or catching of heavy loads will reduce the life of the boom and stick.

# 315 GC Hydraulic Excavator Specifications

## Attachments Offering Guide

Not all Attachments are available in all regions. Consult your Cat dealer for configurations available in your region.

Match

Working range front only

1200 kg/m<sup>3</sup> (2,000 lb/yd<sup>3</sup>)

### PIN-ON ATTACHMENTS

Boom Type		Reach Boom	
Stick Length		R2.5 (8'2")	R3.0 (9'10")
Hydraulic Hammers	H110 GC S	✓	✓
	H110 S	✓	✓
	H115 GC S	✓	✓
	H115 S	✓	✓
Demolition and Sorting Grapples	G312 GC	✓	✓
Mobile Scrap and Demolition Shears	S3015	✓	✓
Compactors (Vibratory Plate)	CVP75	✓	✓
Orange Peel Grapples	GSV520 GC-400	○	○
	GSV520 GC-500	○	○

### CAT PIN GRABBER COUPLER ATTACHMENTS

Boom Type		Reach Boom	
Stick Length		R2.5 (8'2")	R3.0 (9'10")
Hydraulic Hammers	H110 GC S	✓	✓
	H110 S	✓	✓
	H115 GC S	✓	✓
	H115 S	✓	✓
Compactors (Vibratory Plate)	CVP75	✓	✓

### CW-20S DEDICATED COUPLER ATTACHMENTS

Boom Type		Reach Boom	
Stick Length		R2.5 (8'2")	R3.0 (9'10")
Hydraulic Hammers	H110 GC S	✓	✓
	H110 S	✓	✓
	H115 S	✓	✓
Demolition and Sorting Grapples	G312 GC	✓	✓
	G313 GC	✓	✓
	G314	✓*	✓*
Compactors (Vibratory Plate)	CVP75	✓	✓

(continued on next page)

# 315 GC Hydraulic Excavator Specifications

## Attachments Offering Guide *(continued)*

Not all Attachments are available in all regions. Consult your Cat dealer for configurations available in your region.

Match

Working range front only

### CW-20 DEDICATED COUPLER ATTACHMENTS

Boom Type		Reach Boom	
		R2.5 (8'2")	R3.0 (9'10")
Hydraulic Hammers	H110 GC S	✓	✓
	H110 S	✓	✓
	H115 S	✓	✓
Demolition and Sorting Grapples	G312 GC	✓	✓*
	G312 GC Fixed CAN	✓	✓
	G313 GC	✓	✓
Compactors (Vibratory Plate)	CVP75	✓	✓

### S60 DEDICATED COUPLER ATTACHMENTS

Boom Type		Reach Boom	
		R2.5 (8'2")	R3.0 (9'10")
Hydraulic Hammers	H110 GC S	✓	✓
	H110 S	✓	✓
	H115 GC S	✓	✓
	H115 S	✓	✓
Demolition and Sorting Grapples	G312 GC	✓	✓
Compactors (Vibratory Plate)	CVP75	✓	✓

### TRS10-CW-20 ATTACHMENTS

Boom Type		Reach Boom	
		R2.5 (8'2")	R3.0 (9'10")
Compactors (Vibratory Plate)	CVP75	✓	✓

### TRS10-S60 ATTACHMENTS

Boom Type		Reach Boom	
		R2.5 (8'2")	R3.0 (9'10")
Hydraulic Hammers	H110 GC S	✓	✓*
	H110 S	✓	✓
Demolition and Sorting Grapples	G212 GC	✓	✓*
Compactors (Vibratory Plate)	CVP75	✓	✓

### BOOM-MOUNT ATTACHMENTS

Boom Type		Reach Boom
Mobile Scrap and Demolition Shears	S3025	✓

# 315 GC Standard and Optional Equipment

## Standard and Optional Equipment

Standard and optional equipment may vary. Consult your Cat dealer for details.

	Standard	Optional		Standard	Optional
<b>BOOMS, STICKS AND LINKAGES</b>			<b>CAT TECHNOLOGY</b>		
4.65 m (15'3") Reach boom	✓		Cat Product Link™	✓	
2.5 m (8'2") Reach stick		✓	Auto hammer stop	✓	
3.0 m (9'10") Reach stick		✓	<b>ELECTRICAL SYSTEM</b>		
Bucket linkage, with lifting eye	✓		Maintenance free battery	✓	
<b>CAB</b>			Centralized electrical disconnect switch	✓	
Sound suppressed ROPS cab with viscous mounts	✓		LED chassis light, left-hand/right-hand boom lights, cab lights – 1,800 lumens	✓	
High-resolution 203 mm (8") LCD touch screen monitor	✓		Programmable time-delay LED working lights	✓	
Automatic bi-level air conditioner	✓		<b>ENGINE</b>		
Jog dial and shortcut keys for monitor control	✓		Two selectable modes: Power, Smart	✓	
Keyless push-to-start engine control	✓		Automatic engine speed control	✓	
Height-adjustable console, three steps with tool	✓		Automatic engine shutdown	✓	
Tilt-up left-side console	✓		52° C (125° F) high-ambient cooling capacity without derate	✓	
Mechanically adjustable seat suspension	✓		-25° C (-13° F) cold start capability	✓	
51 mm (2") orange seat belt	✓		Electric fuel priming pump	✓	
Bluetooth® integrated radio (no USB, aux port or microphone)	✓		Variable speed fan	✓	
2 × 12V DC outlets	✓		Single fuel filtration system with water separator and indicator	✓	
Document storage	✓		Sealed double element air filter with precleaner	✓	
Cup and bottle holders	✓		Biodiesel capability up to B20	✓	
Openable two-piece front window	✓				
Upper radial wiper with washer	✓				
Openable steel hatch	✓				
LED dome light	✓				
Roller front sunscreen	✓				
Roller rear sunscreen		✓			
Rear window emergency exit	✓				
Washable floor mat	✓				
Beacon ready	✓				

(continued on next page)

# 315 GC Standard and Optional Equipment

## Standard and Optional Equipment *(continued)*

Standard and optional equipment may vary. Consult your Cat dealer for details.

	Standard	Optional		Standard	Optional
<b>HYDRAULIC SYSTEM</b>			<b>SERVICE AND MAINTENANCE</b>		
Electronic main control valve	✓		Grouped engine oil and fuel filters	✓	
Single type electronic pump	✓		Ground level engine oil dipstick	✓	
Boom and stick regeneration circuits	✓		S·O·S <sup>SM</sup> sampling ports	✓	
Automatic two-speed travel	✓		<b>UNDERCARRIAGE AND STRUCTURES</b>		
Boom and stick drift reduction valve	✓		500 mm (20") triple grouser track shoes		✓
Electric boom snubber	✓		500 mm (20") triple grouser track shoes with rubber pad		✓
Swing drive, without fine swing control function	✓		500 mm (20") rubber shoe		✓
Boom and stick lowering check valves		✓	600 mm (24") triple grouser track shoes		✓
Medium-pressure line		✓	700 mm (28") triple grouser track shoes		✓
High-pressure line		✓	2500 mm (8'2") blade		✓
Quick coupler line		✓	2600 mm (8'6") blade		✓
<b>SAFETY AND SECURITY</b>			2700 mm (8'10") blade		✓
Rear and right-side-view cameras	✓		Grease lubricated track link	✓	
Ground level engine shutoff switch	✓		Center track guiding guard	✓	
Service platform with anti-skid plate and countersunk bolts	✓		Bottom without swivel guard	✓	
Signaling/warning horn	✓		Travel motor guards	✓	
			3.83 mt (8,440 lb) counterweight	✓	
			ISO 15818 tie-down points on base frame	✓	

# 315 GC Attachments

## Dealer Installed Kits and Attachments

Attachments may vary. Consult your Cat dealer for details.

### CAB

- Radial lower wiper
- Left-hand and right-hand electrical pedal (two-way) for tool control
- Dual exit rear window kit
- Rain protector plus cab light cover
- Polycarbonate roof hatch
- Front windshield laminated glass (P5A glass, EU demolition regulation)
- Key fob (for use with Bluetooth receiver)

### SAFETY AND SECURITY

- Bluetooth receiver
- 76 mm (3") retractable seat belt

### GUARDS

- FOGS (not compatible with cab light cover, rain protector)
- Mesh guard full front (not compatible with cab light cover, rain protector)
- Mesh guard lower half front
- Full protecting vandalism guard

### OTHER

- Grease gun holder

For more complete information on Cat products, dealer services, and industry solutions, visit us on the web at [www.cat.com](http://www.cat.com)

© 2020 Caterpillar  
All rights reserved

Materials and specifications are subject to change without notice. Featured machines in photos may include additional equipment. See your Cat dealer for available options.

CAT, CATERPILLAR, LET'S DO THE WORK, their respective logos, "Caterpillar Corporate Yellow," the "Power Edge" and Cat "Modern Hex" trade dress as well as corporate and product identity used herein, are trademarks of Caterpillar and may not be used without permission.

AEXQ2918 (07-2020)  
Build Number: 07A  
(Eur)

